

# RADIO & ELECTRONICS CONSTRUCTOR

Vol. 26 No. 10

MAY 1973

20p

229.6

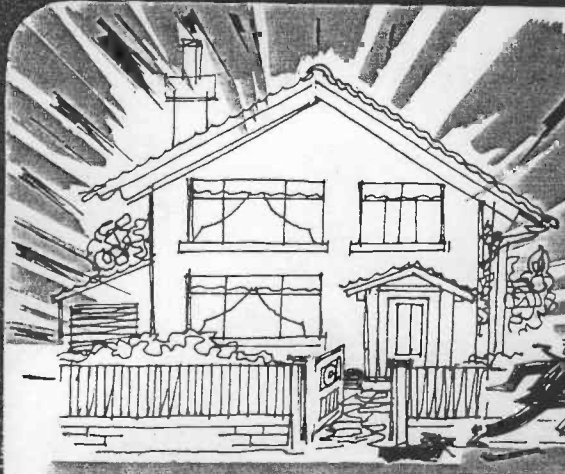

## HOUSEHOLD BURGLAR ALARM

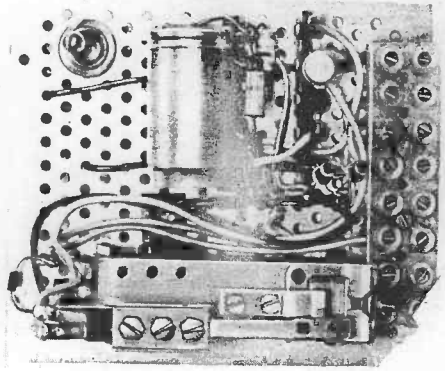
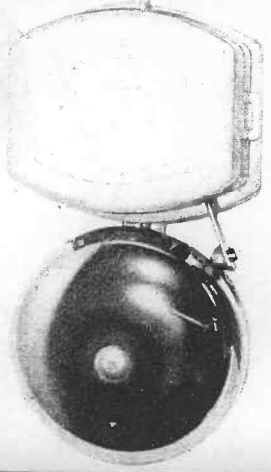

**ALSO  
FEATURED**

In addition to telling you about our Catalogue each month we would like to bring to your notice one or two items which we believe are **UNIQUE TO HOME RADIO (Components) LTD.**

To start off here is the

# 'ERSA' SPRINT IRON



We carry complete spares, right down to the last nut and bolt, even spare mains leads. Our price for this desirable object is only £3.98 plus 18 pence p & p. Essentially this is a tool for the field service engineer or the handyman and experimenter wishing to make a few quick joints. A constructor building something with a large number of joints might find a conventional iron quicker.

- 1** Heats up in 10 seconds!
- 2** Weighs only 5 ounces.
- 3** Parts can be changed in seconds.
- 4** Can be used on anything from a transistor upwards.

*(A friend of ours used one to repair his water tank. We think this is asking too much!)*

The "ERSA" SPRINT IRON is just one of the many exciting things to be found in the famous 250-page Home Radio Components Catalogue. No less than 6,785 electronic components are listed and indexed, and 1,750 items are illustrated. A free bookmark with a useful list of technical abbreviations is included. The catalogue costs 55p plus 22p post and packing. Every copy contains 10 vouchers each worth 5 pence when used as directed. Regularly updated price lists are supplied to you free.



**Send now for catalogue**

Please write your Name, and Address in block capitals

NAME .....

ADDRESS .....



HOME RADIO (Components) LTD., Dept. RC,  
234-240 London Road, Mitcham, Surrey CR4 3HD

**POST THIS COUPON**  
with cheque or P.O. for 77p.

# RADIO & ELECTRONICS CONSTRUCTOR

MAY 1973

CONTENTS

Vol. 26 No. 10

Published Monthly (1st of Month)  
First Published 1947

*Incorporating The Radio Amateur*

Editorial and Advertising Offices  
57 MAIDA VALE LONDON W9 1SN

Telephone 01-286 6141      Telegrams Databux, London

© Data Publications Ltd., 1972. Contents may only be reproduced after obtaining prior permission from the Editor. Short abstracts or references are allowable provided acknowledgement of source is given.

Annual Subscription: £2.70 (U.S.A. and Canada \$7.00) including postage. Remittances should be made payable to "Data Publications Ltd". Overseas, readers please pay by cheque or International Money Order.

Technical Queries. We regret that we are unable to answer queries other than those arising from articles appearing in this magazine nor can we advise on modifications to equipment described. We regret that such queries cannot be answered over the telephone; they must be submitted in writing and accompanied by a stamped addressed envelope for reply.

Correspondence should be addressed to the Editor, Advertising Manager, Subscription Manager or the Publishers as appropriate.

Opinions expressed by contributors are not necessarily those of the Editor or proprietors.

Production.—Web Offset.

Published in Great Britain by the Proprietors and Publishers, Data Publications Ltd, 57 Maida Vale, London, W9 1SN

The Radio & Electronics Constructor is printed by Carlisle Web Offset.

**JUNE ISSUE WILL BE PUBLISHED ON JUNE 1st**

THE 'HIFLEX' PERSONAL RECEIVER by Sir Douglas Hall, K.C.M.G., M.A. (Oxon)	612
QSX by Frank A. Baldwin	617
NEWS AND COMMENT	618
ISOLATED TRIAC CONTROL CIRCUIT (Suggested Circuit 270) by G. A. French	620
NEW EDDYSTONE RECEIVER	623
METAL OXIDE VARISTORS by J. B. Dance, M.Sc.	624
RECENT PUBLICATIONS	626
R-S PRECEDENCE DETECTOR by R. J. Caborn	627
TWO METRE HALO FOR BOAT USE by Arthur C. Gee, G2UK	630
HOUSEHOLD BURGLAR ALARM by J. R. Davies	632
MODIFICATIONS TO CYCLOPS—Part 2, by L. C. Galitz	638
CLUB EVENTS	643
CAN ANYONE HELP?	643
SHORT WAVE NEWS by Frank A. Baldwin	644
NEW PRODUCTS	646
IN YOUR WORKSHOP— Unusual Facets of Resistance	647
RADIO TOPICS by Recorder	655
CONSTRUCTOR'S DATA SHEET No. 74 (Resonant Frequencies—II)	iii

# THE 'HIFLEX' PERSONAL RECEIVER

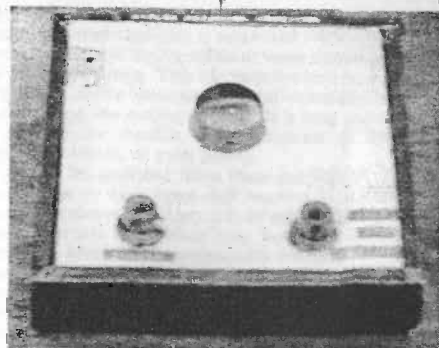

Although this receiver employs only two transistors, reflex operation provides two stages of r.f. amplification before detection, together with a further two stages of a.f. amplification after detection.

by

Sir Douglas Hall, K.C.M.G., M.A. (Oxon)

THIS RECEIVER EMPLOYS A FURTHER NEW DOUBLE reflex circuit, and it gives high amplification with only two transistors. It employs a field-effect transistor which functions as a source follower, first at radio frequencies and then at audio frequencies, and a high amplification bipolar p.n.p. transistor which amplifies, as a common emitter device, at both radio and audio frequencies. As a result a large number of stations can be received, both on the medium and the long wave bands, these signals giving good volume and quality on a pair of cheap crystal earphones. Selectivity will not approach that given by a superhet, nor will it be as good as can be obtained with the author's 'Spontaflex Super Alpha' circuits, but it is adequate for most areas. The coverage on the two bands is from about 150 to 550 metres on medium waves, and from below 1,000 to above 2,000 metres on long waves.

## CIRCUIT OPERATION

The circuit is shown in Fig. 1. Assume first that the wave-change switch, S1(a), is set to medium waves, thereby short-circuiting L1 and causing VC3 to be inoperative. Medium wave signals are picked up on the ferrite rod coil L1 this being tuned by VC1 which is a solid dielectric 200pF tuning capacitor. The signal is applied to the gate of TR1 and, since the input impedance of this transistor is extremely high, the whole of the tuned circuit can be applied to the gate without any

damping taking place. The signal next appears at the source of TR1 where it has a lowish impedance of some hundreds of ohms. The r.f. signal is applied to the base of TR2 and is then fed, in highly amplified form, to L3 via C2. D1, a germanium diode, rectifies the signal which is then reapplied in audio form, to the gate of TR1 by way of L1. The a.f. signal is next passed to the base of TR2 and, again much amplified, appears across the inductor L4, which is the large winding of an interstage transformer. The d.c. resistance of L4 should not exceed about 1kΩ or there will be too large a drop of voltage across it and TR2 will not function properly. The Eagle LT44, universally obtainable, is satisfactory here, but the earlier Rex LT44, no longer normally available, had a d.c. resistance of 2kΩ for its large winding and this is too high for the present circuit.

C2 and L3 have negligible effect at audio frequencies. R3 is the normal emitter resistor for TR2, with C1 connected across it to prevent negative feedback of the signal.

There will, of course, be a radio frequency signal at the collector of TR2, and this is prevented from reaching the output sockets by the filter given by R4, C4 and R5. R4 is effectively in parallel with L3 at r.f. and forms part of the r.f. load for TR2.

VC2 provides a capacitive tap into the tuned circuit and enables regeneration to be obtained by means of the Colpitts method, this having the advantage of dispensing with a coupling winding on the ferrite rod. Regeneration

Fig. 1. The theoretical circuit of the 'Hiflex' personal receiver. There is an adjustable inductive coupling between L3 and L1. The receiver is switched off when S1 (a) is in the centre position

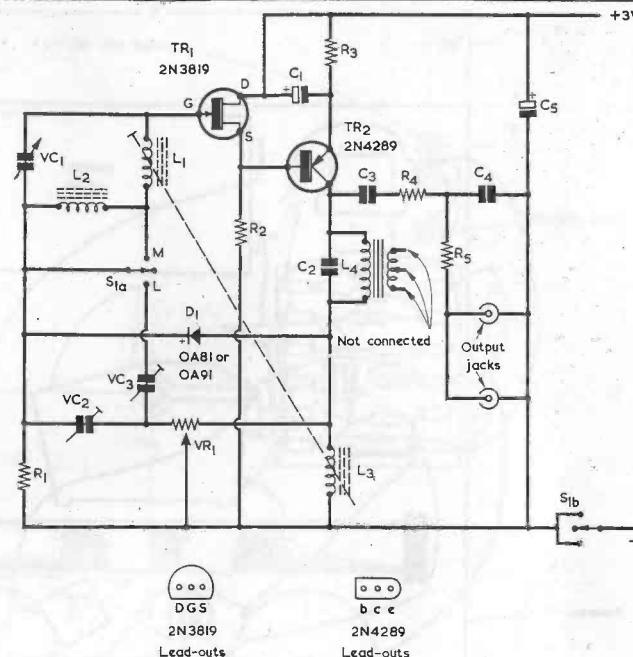

## COMPONENTS

### Resistors

(All fixed values  $\frac{1}{4}$  watt 10%)

R1	100kΩ
R2	1kΩ
R3	1kΩ
R4	4.7kΩ
R5	3.3kΩ
VR1	2kΩ or 2.2kΩ potentiometer, linear

### Capacitors

C1	80μF electrolytic, 2.5V. Wkg.
C2	0.002 or 0.0022μF paper or plastic foil
C3	0.1μF paper or plastic foil
C4	0.002 or 0.0022μF paper or plastic foil
C5	800μF electrolytic, 4V. Wkg.
VC1	200pF variable, 'Dilecon' (Jackson Bros.)
VC2	60pF trimmer, mica
VC3	750pF trimmer, mica

### Inductors

L1	See text
L2	See text
L3	2.5mH r.f. choke type CH1 (Repanco)
L4	Interstage transformer type LT44 (Eagle)

### Semiconductors

TR1	2N3819
TR2	2N4289
D1	OA81 or OA91

### Switch

S1	3-pole 3-way or 3-pole 4-way, miniature rotary
----	--

### Sockets

2	2.5mm. jack sockets
---	---------------------

### Phones

2	crystal earphones with 2.5mm. jack plugs
---	--

### Battery

2	cells type U7 or HP7 (Ever Ready)
---	-----------------------------------

### Miscellaneous

2	ferrite rods, 4in. by $\frac{3}{16}$ in. (see text)
1	battery holder type BH2 (Eagle)
3	knobs (see text)
1	transistor holder (optional - see text)
1	6-way miniature tagboard, $1\frac{1}{2}$ by $1\frac{1}{2}$ in.
	Plywood, Fablon or Contact, etc.



is further helped, particularly at the lower radio frequencies, by arranging a measure of inductive coupling between L1 and the choke L3.

When S1(a) is set to long waves, the ferrite rod coil L2 which is mounted at right angles to L1) is brought into circuit in series with L1. Also, a further capacitive tap capacitor, VC3, is connected in parallel with VC2.

Regeneration is controlled by VR1. This component is coupled to the capacitive tap capacitors and, as it is adjusted, varies their effect. The track of VR1 on the opposite side of the slider couples to L3. When VR1 is set to minimum, it not only presents its full track resistance to the capacitive tap capacitors but it also short-circuits L3 and deprives TR2 of an r.f. collector load. Hence, VR1 functions as a true radio frequency volume control as well as a regeneration control.

C3 is a d.c. isolating capacitor, and C5 is the usual large electrolytic capacitor connected across the battery. Note that only a 3 volt supply is needed and that a higher supply potential should not be used. The current drain from the battery is approximately 2.7mA, of which about 1.7mA is drawn by TR1 and about 1mA by TR2. Crystal earphones *must* be used, and magnetic types will not prove suitable. Two single earphones may be employed, these being plugged into the two jack sockets.

The components required are generally available. The 2 or 2.2kΩ potentiometer required for VR1 can be obtained from a number of suppliers, including Henry's Radio and Electrovalue. Switch S1 is a 3-pole 3-way or 3-pole 4-way component, despite the fact that only a 2-way switch is illustrated in Fig. 1. This is because one of the tags on an unused section of the switch is employed as an anchor tag. Some of the components are wired on a miniature 6-way tagboard measuring approximately 1½ by 1½ in. This can be obtained from Home Radio under Cat. No. BTS13. A further point is that L1 and L2 are wound on ferrite rods 4in. long by ½ in. diameter. These were obtained from Amatronics Ltd., 396 Selsdon Road, South Croydon, CR2 0DE. Rods obtained from alternative sources may be of different grade and could give different results.

## PURPOSE

This small piece of apparatus has been designed as a simple personal receiver rather than as a tuning head, and its performance with all types of a.f. amplifier has not been tried out. It works well, however, with the author's 'Sliding Challenger' amplifier,\* the overall sensitivity of the combination being very high. Ideally, the input impedance of the amplifier should be about 10kΩ but a lower impedance will prove quite satisfactory with some small drop in sensitivity. If the input impedance of the amplifier is higher than about 20kΩ there may be some loss in quality, and there might be instability if the amplifier is set to full volume. For maximum selectivity with an a.f. amplifier, the receiver regeneration control should be set near the oscillation point, and volume controlled by the amplifier's volume control. The use of a high gain amplifier without a volume control in its input circuit is not recommended. It may well be found, when using the 'Sliding Challenger' amplifier with this receiver, that the amplifier volume control has to be turned well back on some

\*Sir Douglas Hall, 'The "Sliding Challenger" 200-250 mW Economy Amplifier', *The Radio Constructor*, August 1970.

signals to avoid overloading or even instability. If a mains-powered amplifier is employed there may well be break-through of strong medium wave signals picked up by the mains wiring. This can be prevented by inserting a 2.5mH r.f. choke between the negative supply line of the receiver and the output sockets. If a long wave station is causing the trouble, the inductance of the choke should be 10mH, or even 20mH.

As will be gathered from these comments, it is preferable not to look upon this receiver as a unit which can be employed with any a.f. amplifier. Since working on this article the author has, however, built an a.f. amplifier which has been specially designed for use with the 'Hiflex' receiver and the constructor may add this amplifier at a later date if he so desires, using the receiver for the time being with the crystal earphones. The amplifier, which also operates from a 3 volt supply, will be described in a future issue of this journal.

## CONSTRUCTION

Construction is very simple, and both the component layout and the wiring are illustrated in Fig. 2. A piece of ½ in. plywood is cut out, and three ½ in. holes are drilled to take VC1, S1 and VR1 as shown. In addition a slot is cut to take the clamp of L4, which is then cemented into the slot: and two holes are drilled for the two earpiece jack sockets. These holes will require countersinking on the top side of the panel (i.e. on the side away from the reader as shown in Fig. 2) to make quite sure that the plugs of the earphones can be fully inserted. If this is not done there may be a mysterious silence when the receiver is tried out!

The two ferrite rod coils are next made up. They are both wound on sleeves and that for L1 must be loose enough to allow it to be moved along the rod when setting up the receiver. A useful method of making up the sleeves is to employ pieces of Fablon or Contact with all the backing left on except for a strip about ½ in. wide. The material may then be wrapped around the ferrite rod, being stuck to itself by the ½ in. strip of exposed adhesive.

L1 has 85 turns of 28 s.w.g. enamelled wire and L2 400 turns of 38 s.w.g. enamelled wire. Both windings are single-layer close-wound. Rubber or p.v.c. grommets are fitted at the ends of each rod, and these are secured to the panel by cord passed round the grommets, two small holes at each grommet being drilled in the panel to take the cord. The rods must not be secured with wire, which could constitute a 'shorted turn'.

The small components are wired up on the 6-way miniature tagboard. In Fig. 2, the two transistors, R1, VC2 and C5 are shown outside the tagboard edges for clarity, but they should in practice be within these edges. No component should be higher, above the tagboard undersurface, than ½ in. The tagboard is then fitted to the plywood with small woodscrews, the area of the plywood under the tagboard having been previously covered with a piece of Fablon or Contact. This ensures that the undersides of the tagboard tags do not make contact with the plywood, which may not be a perfect insulator.

Care should be taken to ensure that TR1 is not damaged during soldering. One approach to this end consists of short-circuiting its leads together with thin fuse wire, this being removed after the transistor has been wired into circuit and the remainder of the receiver wiring has been carried out. Another approach consists

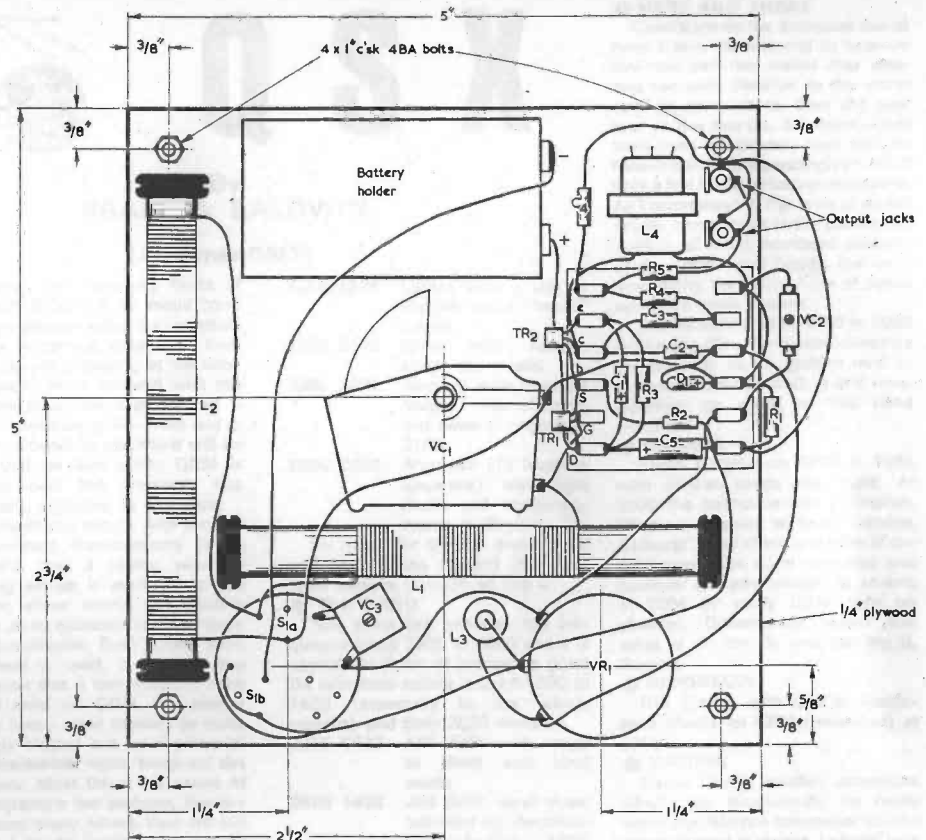

Fig. 2. All the components are assembled on a plywood panel, and are wired up as shown here

of employing a transistor holder. This is wired into circuit instead of the transistor, the latter being fitted into it after the receiver wiring has been completed.

Choke L3 should be connected into circuit with slightly longer leads than would normally be used, as its position and orientation with respect to L1 will need to be varied when setting up the receiver. It should be wired initially in approximately the position indicated in Fig. 2, its ferrite core being vertical.

In the diagram, S1 is shown as a 3-pole 3-way switch, one tag of the unused section being employed as an anchor tag for VC3. If a 3-pole 4-way switch is employed there will be two unused sections, and VC3 can be anchored to any conveniently positioned tag of either of these.

The holder for the two U7 cells is either secured in position with adhesive, or held by a metal strip cut from tinplate or similar which passes over the length of the holder and its clip. There is no need to move the holder after it has been fitted, but it must of course, be possible

to remove and fit the cells. The battery holder must be positioned such that it does not foul the moving vanes of VC1 when these are rotated.

Four 4BA countersunk bolts, each 1in. long, are fitted at the corners of the panel. These enable the 'chassis' to stand on a flat surface without any of the components touching it.

## TESTING

When wiring has been completed, the receiver may be tested and set up.

First, set VC2 and VC3 to maximum capacitance. Similarly set VC1 to maximum capacitance and switch S1 to medium waves. This is given when S1 knob is turned clockwise. Advance VR1 in a clockwise direction. It may well be that a hiss, denoting oscillation, will be heard in the earphones when VR1 is advanced to a certain point. Adjust the angle of L3, and the position of L1 coil on its rod, so that the hiss starts when VR1

has advanced by about one-third to one-half of its travel. If difficulty is found in obtaining oscillation, take L1 coil off its rod and refit it the other way round, or reverse its connections to VC1 and S1(a). Do not carry out both of these changes as they will cancel each other out. It is unlikely that this exercise will prove necessary, as adjustments to the angle of L3 will probably be sufficient to produce oscillation regardless of which way round L1 is connected.

Next, set VC1 to minimum capacitance with the vanes fully open. It will probably be found that oscillation, denoted by the hiss, cannot be obtained even when VR1 is fully advanced. In this event, reduce the capacitance of VC2 until the hiss starts when VR1 is advanced one-third to one-half of its travel. Check back with the vanes of VC1 fully enmeshed and, if necessary, reset the angle of L3 or slightly alter the position of L1 on the rod for correct oscillation. Then check again with VC1 at minimum capacitance and, if necessary readjust VC2.

Now tune in a station near the high frequency end of the medium wave band with the vanes of VC1 almost fully disengaged. If there are no selectivity problems, leave well alone. If there is an overlap of stations, slightly reduce capacitance of VC2. This may require a small readjustment of L3 or L1 if reception at the low frequency end of the band is to remain satisfactory.

Turn S1 to the long wave position. Adjust VC3 so that smooth reaction, as denoted by a gradual onset of the hiss, is obtainable throughout the band. If this state of affairs cannot be achieved, take L3 coil off its rod and replace it after turning it through 180 degrees. It is probable that oscillation will start on the long wave band with VR1 advanced not more than one-third of its travel. It is also likely that the best setting for VC3 will be at maximum or nearly maximum capacitance.

This setting-up procedure is really very simple and will probably take little longer to carry out than it does to read the foregoing description. However, the following notes may be useful.

**Medium wave band.** If VC2 has too high a capacitance there will be poor selectivity and it may prove impossible to obtain oscillation with the vanes of VC1 fully open. If VC2 has too low a capacitance, oscillation at high frequency settings of VC1 will start at an early setting of VR1; and there will also be a loss of sensitivity. It may also prove impossible to obtain oscillation at the low frequency end of the band. The setting of VC2 has the greater effect at the high frequency end of the band; and the relative positioning of L1 and L3 has the greater effect at the low frequency end of the band.

**Long wave band.** On this band, make sure that L2 is fitted, on its rod, of the way round which gives best results. If VC3 is set to too high a capacitance there may be 'rough' reaction, oscillation at high frequency settings of VC1 being accompanied by a grunt or howl. There will also be poor selectivity. If VC3 is set to too low a capacitance there may be backlash in VR1 when VC1 has its vanes fully enmeshed. 'Backlash' refers to the condition where oscillation starts at a certain setting of VR1 but does not stop again until VR1 has been turned back a considerable way. When VC3 is properly adjusted, the oscillation position for VR1 will be closely defined with oscillation ceasing as soon as VR1 is turned back over a fraction of its travel. It is just possible that conditions will seem to commence improving as VC3 is set to maximum capacitance, giving the impression that performance would be better again if this component had greater capacitance. Should

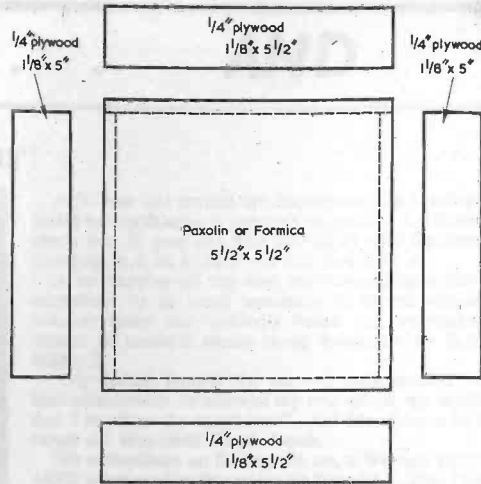

Fig. 3. A simple case may be made up using four pieces of plywood and a Paxolin or Formica panel

this occur, connect a fixed capacitor of 300 to 500pF across VC3, and readjust it.

#### CALIBRATION

As soon as the best setting for VC2 and VC3 have been found, the receiver may be calibrated. Calibration should not be attempted until these two trimmers have been finally set up, as their adjustment affects tuning slightly, particularly when the vanes of VC1 are nearly fully open. Station positions and wavelengths may be marked out on a card measuring 5in. by 5in. which, with suitable holes for the spindles of VC1, S1 and VR1, and for the earphone sockets, is fitted in position over the plywood panel. If small knobs are employed for S1 and VR1, a large knob, up to about 4in. in diameter, can be used for VC1. This will make tuning an easy matter. Large knobs are not, unfortunately, commonly available, and they tend to be very expensive when they can be obtained. The author made his own by using a 1in. diameter knob and cementing over this a 4in. diameter disc of Perspex with a hole at the centre which was a tight fit over the knob.

Many stations will be received, especially after dark, with the result that calibration is simple on both bands.

Finally, a small case can be made up using four pieces of plywood and a panel of Paxolin or Formica, as shown in Fig. 3. The bottom edges of the plywood pieces are screwed to the panel as indicated by the broken lines, the result being an open-topped box measuring 5½ by 5½in. with a height of 1¼in. plus the thickness of the panel. This box is covered with Fablon or Contact. The receiver 'chassis' is dropped into position in the box and, provided the latter is a good fit, no form of fixing has been found necessary. The dimensions given in Fig. 3 assume that the plywood panel of Fig. 2 has been accurately cut exactly 5in. square. If this is not the case the dimensions in Fig. 3 should be modified to suit the actual size of the plywood panel.



# Q S X

By  
**FRANK A. BALDWIN**

(All Times GMT)

Between the frequency limits of 3200 and 3400, the 90 metre band can often provide some Dx reception at times. In general, quite apart from the conditions prevailing at the time, the operator must contend with the utility transmissions that abound – virtually cheek-by-jowl – from end to end of the band. In practice it will be found that far less utility QRM is apparent over the weekend, this particularly applying to Sundays.

To obtain any results with respect to broadcast transmissions it is imperative that a highly selective receiving set-up is available to the operator, either within the receiver itself or as an outboard ancillary such as a Q-multiplier. Even where such equipment is used, it is often the experience that a transmission, once located amid the QRM, will sooner or later (more often sooner) be quite suddenly blotted out by a powerful utility transmitter right 'bang-on' the frequency. Most Dxers are aware of the frustrations but perhaps, like the writer and many others, they are still prepared to do battle with the 90 metre band in order to come up with some worthwhile logging from time to time. In fact, almost any logging on this band is worthwhile considering the difficulties one must surmount at times.

#### 90m BAND STATIONS

- 3200 2306 PLA Fukien with male and female announcers in Chinese dialect, military marches etc.
- 3205 1640 AIR Lucknow with programme in Hindi, channel surrounded by a sea of utility QRM.
- 3240 2223 Baghdad with Arabic music and songs, quite the easiest station to log on this band.
- 3260 2203 Niamey with African music, announcements in vernacular, National Anthem and sign-off.
- 3336 2229 Ziguinchor with European songs and music recordings.

3346 1926

Lusaka with a talk in English under "open" carrier.

3350 2210

Ejura with African songs and music.

3380 2051

Blantyre with classical music, identification and news in English at 2100.

3396 2010

Rhodesia (Tx location uncertain) with light music and announcements in English.

So much for the 90 metre band and on to those stations that have been coming through on the –

#### 75m BAND

This band lies between the frequency limits 3900 to 4000 and it is capable at times of producing good Dx reception mainly around 1500 to 1630 (especially in the winter months) and from 2030 onwards.

3905 1633

AIR Delhi with songs in Hindi and local music.

3925 1628

AIR Delhi, local music followed by identification in English at 1630.

3930 2349

Radio Barlavento, light music with announcements in Portuguese (actually measured on 3931).

3940 2155

Wuhan, Hubei, Chinese music with announcements in Chinese dialect.

3940 1619

Rawalpindi with talk in English on current affairs in Pakistan.

3999 0127

Gronlands Radio, talk by OM in Greenlandic.

4035 0045

Lhasa with OM in (presumably) Tibetan. The frequency is just outside the band limits, the channel is subject to severe interference from an 'open' carrier just HF, a 1.2kHz pass-band is needed for this one and the logging is tentative, no identification being heard – still less understood!

#### HERE AND THERE

Conditions on the Broadcast bands have slowly commenced to improve over the past few weeks after what one can only describe as the worst spell in many years. Over the past four or five months, the noise levels have been inordinately high and the resulting Dx correspondingly low with only a few bright periods on occasions. As I understand it, this view of recent events corresponds to the considered opinion of many seasoned veterans of the short wave bands, the hope now being that some form of cyclic normality soon returns.

The frequency limits 4750 to 5060 define the 60m Band, considered by the writer to be the 'golden mile' of Broadcast band Dx trading as it were. Opening up shop on this band produced –

#### GAMBIA

Radio Gambia on 4820 at 1955 with African songs and music. At 2000 the announcement in English, "You are listening to Radio Gambia, Bathurst", time check and relay of the BBC news. The good reception was however abruptly brought to an end at 2004 by utility QRM right on channel. Occasionally, when this noise is off the air, one can log R. Gambia.

#### INDONESIA

RRI Medan with OM in Arabic-style chants on 4764 (measured) at 2318.

#### NIGERIA

Benin City is another transmitter which can occasionally be heard when the teletype transmitter on the same channel is absent. Logged here at 2303 on the regular 4932 outlet.

#### IVORY COAST

Radio Abidjan on 4940 at 2044 with the pop tune "Last Waltz" in English under the identification "Govorit Kiev" on same channel.

#### MALI

Radio Mali, Bomako, still shifting around from the listed 4783, heard on a measured 4786.5 at 2035 with African drums after identification by YL in French.

#### TANZANIA

Dar-es-Salaam on regular 4785 at 2224 with African drum and chants.

#### INDIA

AIR Delhi, newscast in English read by YL on 4860 at 2318.

#### NEPAL

Radio Nepal on 5000 (just slightly LF of MSF) at 1543 with Asian-type songs and OM in Nepali through MSF transmission.

#### ZAIRE

Lubumbashi at 2235 on a measured 4744 (listed 4750) with African music and song programme.

## OLD CRYSTAL SET IS "A TREASURE"



Photograph shows Mr. Benson listening to Radio 2 on his crystal set which could be one of the oldest working models in Britain. Its makers, Western Electric, put out experimental broadcasts from Station 2WP in Norfolk Street, London, from October, 1922 until moving to Birmingham in November that year where the call sign was 5 IT. In 1929 they began to make sound equipment for 'talkies'.

A 50 year old crystal set discovered in a Leeds attic could be worth several hundred pounds. It is a museum piece, but 71 year old SID BENSON who remembers listening to it as a child will not part with it.

After blowing-off the dust and connecting a pair of earphones to its brass terminals he turned the cat's whisker tuner and suddenly heard the unmistakable strains of modern music being broadcast by B.B.C. Radio 2.

"My father, bought the set way back around 1922 and occasionally he allowed my two sisters, my brother and I to share the earphones", said Mr. Benson at his home off Wakefield Road, Leeds.

His enthusiasm on finding the set, a Western Electric 44001 receiver, was shared by his friend Mr. Don Perry, a former radio engineer, who helped to establish the fact that because of its "B.B.C. Approved" stamp it had been made before July 1924. According to a researcher, Mr. Peter West of Fontmell Magna, near Shaftesbury, the royalties the B.B.C. drew from receivers ended in July, 1924, and the stamp was no longer used. "It is something of a treasure", he told Mr. Perry.

## EMI TO SUPPLY IBA WITH TRANSMITTING AERIALS FOR COMMERCIAL BROADCASTING

EMI has been awarded contracts totalling more than £160,000 to provide the Independent Broadcasting Authority with transmitting aerial systems for Britain's first commercial radio stations.

Altogether six systems are to be supplied by the Telecommunications Group of EMI Sound & Vision Equipment Ltd., Hayes, Middlesex, to cover five major cities throughout the country including London, Birmingham, Glasgow and Manchester. Transmissions from the new stations are expected to commence towards the end of 1973.

Two VHF aerials have been specified for London and Birmingham, which will be the first of their type in this country, utilising circular polarisation techniques. These techniques are used extensively in the United States to give improved reception for transistor and car radios.

The aerial system for London, which is 60ft. high, will be installed on the top of the 500ft. television tower at the IBA Croydon transmitting station. This aerial will transmit two programmes to the London area. The second VHF system will be mounted on the 1000ft. mast at the Lichfield transmitting station, near Birmingham.

Four medium frequency directional aerial systems are to be supplied to cover four cities. These systems comprise groups of three or four mast radiators with an average height of 220ft. and spacing of 400ft. This arrangement is designed to make maximum use of the limited frequency space allocated in the medium wave band.

These aerials, because of the ground area required, will be sited at new locations near the cities they serve instead of at existing IBA transmitting stations.

First to be supplied to the IBA is the 60ft. high VHF aerial system for London, which is pictured here during its check-out programme at EMI's aerial test site at Hayes, Middlesex.

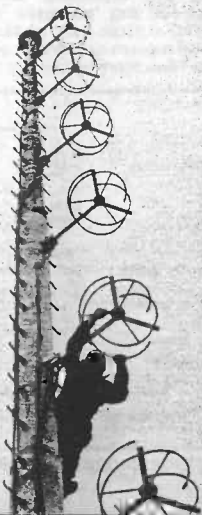

## RECMF CELEBRATES 40th ANNIVERSARY

This month, coinciding with the 23rd international London Electronic Component Show at Olympia, London, from 22 - 25 May, the Radio and Electronic Component Manufacturers' Federation celebrates the 40th anniversary of its foundation. Since 1933, the RECMF exhibitions have become the barometer of the electronics world, reflecting technological developments and advances in all branches of the industry.

On the world scene, the whole electronics industry has seen a shift of emphasis from aerospace to that of the consumer goods field. Colour televisions, pocket calculators, cameras, motor cars, washing machines, hi-fi, radio and even musical instruments are creating large markets for all types of electronic components. Arising from this and the formation of new trading areas within the EEC, this year's LECS is attracting world-wide interest with over one fifth of the nearly 450 exhibitors coming from overseas.

In the United Kingdom the Government's £10 million grant for microelectronics has provided extra encouragement for the British electronics industry and having survived the recent recession, many major companies, absent from such events during recent years, will be participating in the 1973 show.

Visitors to the show will be able to examine products and ideas from every branch of the international electronics industry.

## IN BRIEF

- Henri Picard & Frere Ltd., the suppliers of special-purpose tools for electronic production and servicing have moved to 357/359 Kennington Lane, London, SE11 5HY.

- Mr. B. P. Davies, Director of Bi-Pre-Pak Ltd., recently negotiated the sale of 1,000,000 transistors to dealers in Hong Kong!

Further consignments from Bi-Pre-Pak will constitute a considerable percentage of the overall requirements of the principal set manufacturers there.

- The Hon. Secretary of the British Amateur Radio Teleprinter Group, G. P. Shirville, G3VZV, has changed his address to 2 Orchard Close, Toddington, Dunstable, Beds. Tel: Toddington 2470.

- The first Company to receive the approval of the British Standards Institute for the manufacture of Reed Contact Units (Reed switches) to meet the requirements of the BS 9000 scheme for electronic components of assessed quality - is Messrs. FR Electronics of Wimborne, Dorset.

- The Radio Society of Great Britain's Education Committee hope to arrange a residential weekend course for RAE instructors in the Autumn. Anyone interested should write to the chairman of the committee - D. M. Pratt, G3KEP, 30 Lyndale Road, Eldwick, Bingley, Yorkshire, BD16 3HE.

MAY 1973

## "TILT"

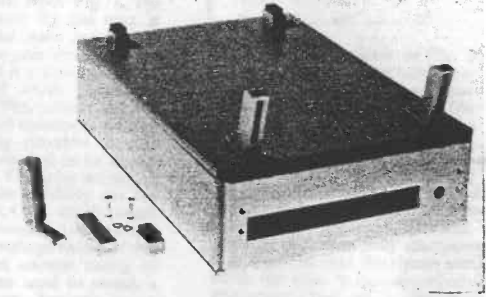

West Hyde Developments Ltd., of Ryefield Crescent, Northwood, Middx., are supplying instrument manufacturers with a new means of tilting the viewing end of instruments upwards to facilitate reading by the user. As an alternative to the usual handle/stand arrangement, or bent chromed rod, the Contil "scope" feet provide a low cost, easily fitted, attractive means of tilting an instrument.

The Contil "scope" feet are moulded in a grey material with black anti-slip inserts. In the extended position, the front of an instrument can be raised by at least 39 mm., whilst when not in use the instrument rests on the anti-slip inserts in a level position.

Fixing is by means of two holes and one M4 screw per foot (supplied), to facilitate easy fixing during production.



"Fool not that sort of test equipment!"



# ISOLATED TRIAC CONTROL CIRCUIT

by G. A. FRENCH

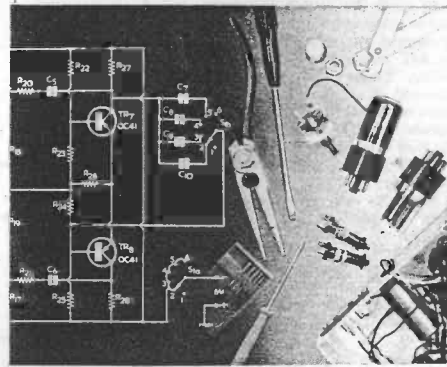

The triac, sometimes referred to as a triode thyristor, is an interesting device which offers a number of useful applications. It has a trigger action and is capable of switching on an alternating current when a much smaller control current is fed to its gate. It can therefore be used in place of a relay, compared with which it has the advantages that switch-on and switch-off are virtually instantaneous and that there are no contacts or mechanical parts to wear out.

## TRIAC OPERATION

THE COMMONLY EMPLOYED circuit symbol for a triac is given in Fig. 1. Here, one terminal of the device is referred to as 'main terminal 1' (or 'anode 1'), another is referred to as 'main terminal 2' (or 'anode 2'), whilst the third is referred to as the 'gate'. The device can be employed in a basic circuit of the type shown in

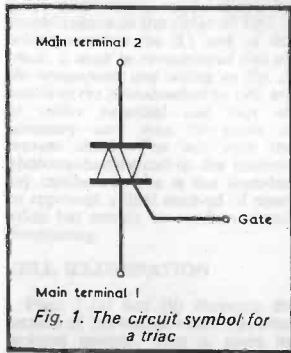
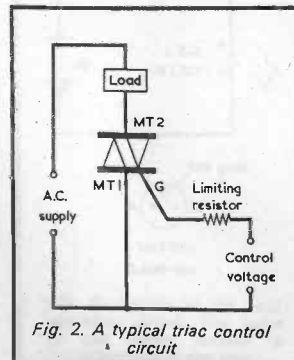

Fig. 2. When in this diagram a source of control voltage, which can be a.c. derived from the a.c. supply or d.c. of either polarity, is applied to the series limiting resistor a gate current flows and the triac becomes conductive, thereby switching the a.c. supply to the load. In a similar manner to the thyristor the triac stays conductive as soon as it has been triggered, and it can only be made non-conductive again by reducing the voltage across its two main terminals to zero. In Fig. 2 this occurs at the end of each half-cycle of the a.c. supply. In consequence, the triac turns off at the end of each half-cycle, only to be turned on again by the gate current at the start of the next half-cycle. When the source of control voltage is removed the triac remains conductive until the end of the half-cycle during which this has happened, and it then stays non-conductive on the succeeding half-cycles.

There are four possible modes of operation for the triac, these being given when the main terminal 2 is positive and the gate is positive, when the main terminal 2 is positive and the gate is negative, when the

main terminal 2 is negative and the gate is negative, and when the main terminal 2 is negative and the gate is positive. These modes are often referred to as 'quadrants' (because they can be represented in a graph having four quadrants) and the minimum triggering gate current requirement for each mode is different. In Fig. 2, the triac changes from one mode to a second mode and then



back to the first mode again on three successive half-cycles. If, in consequence, the gate current is sufficient for the more sensitive of the two modes but is insufficient for the less sensitive mode, the triac may only turn on during the alternate half-cycles which correspond to the more sensitive mode. Should the triac be used as a simple switching device it is necessary to apply a gate control current which is more than adequate for the less sensitive mode, and to thereby ensure reliable switch-on for both modes and for all half-cycles.

When the triac is off the leakage current it passes, at peak voltage between the main terminals, is of the order of 1mA maximum and can in practice be much less. When the triac is conducting the voltage between its main terminals is normally lower than some 2 volts. In consequence, the triac dissipates relatively little heat in both the non-conducting and conducting conditions. Greatest power dissipation, assuming a resistive load, is given at half supply voltage when the voltage across the main terminals is equal to the voltage across the load, and this circumstance arises at an instant during the transition from the non-conducting to the conducting state. This transition is swift, however, and the period of high dissipation extremely short, whereupon the overall effective power which has to be dissipated at half supply voltage is very small. Because of the relatively low dissipation of the triac from all causes, quite small devices are capable of switching surprisingly high values of alternating current.

Triacs are rated at a maximum voltage between main terminals 1

and 2, and the peak value of the switched alternating voltage must not be allowed to exceed this voltage rating. Thus, a triac with a maximum voltage rating of 400 may be employed to switch 240 volt a.c. mains circuits. A more precise term for the maximum voltage rating is 'repetitive peak off-state voltage' and this is normally shown in abbreviated form as V<sub>DRM</sub> or V<sub>DRM</sub>.

As can be seen from Fig. 2, the gate control circuit for the triac is common with the main terminal 1, and the common connection can be a disadvantage if it is desired to have a control circuit which is isolated from the mains. This article describes a simple means of obtaining isolated control, it being possible for the isolated control current to be as low as 10mA or so. The triac employed by the author for checking out the circuit was an R.C.A. 40430 (available from Electrovalue Ltd.), which has a maximum voltage rating of 400 and a maximum current rating of 6 amps. This was used to switch a standard 100 watt domestic lamp. The author has not checked circuit operation with other triacs.

## CIRCUIT

The major section of the triac control circuit appears in Fig. 3. Here, the main terminal 1 of the 40430 connects to one side of the mains supply whilst the main terminal 2 connects to the other side via the 100 watt lamp. Coupled to the gate and main terminal 1 is the control network around TR1, this being powered by a d.c. supply having a nominal voltage of 10 volts.

In the control network, PC1 is an

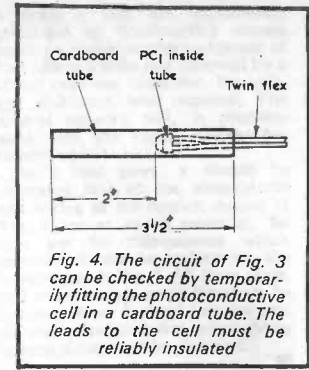
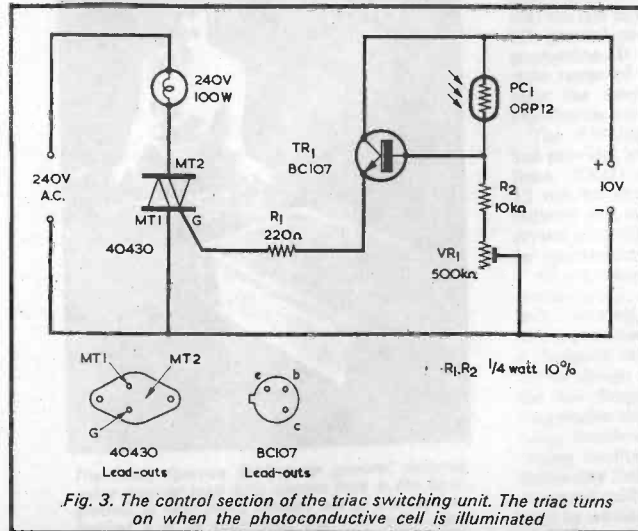

ORP12 photoconductive cell, the resistance of which varies from several megohms or more in darkness to 300Ω or less when fully illuminated. It is intended that the circuit should cause the triac to turn on when the photoconductive cell is illuminated, and to turn off when the photoconductive cell is not illuminated.

Circuit operation is quite simple. When the photoconductive cell is not illuminated it exhibits a high resistance, whereupon the voltage at the base of transistor TR1 is relatively low. This transistor, a BC107, functions as an emitter follower and the voltage on its emitter is similarly low. If the l.d.r. is now illuminated it exhibits a low resistance, causing a much higher voltage to appear at TR1 emitter similarly rises, allowing a current to pass through R1 to the gate of the triac which is sufficiently high to turn it on. VR1 functions as a sensitivity control and the illumination level of PC1 and the setting of this potentiometer are made such as to ensure that the triac is brought fully into conduction when turned on. This requirement is not at all critical and it is an easy matter to find the final conditions which are needed.

The components in the control network of Fig. 3 are all standard parts which can be easily obtained. VR1 could conveniently be a skeleton component. The ORP12 photoconductive cell may be referred to as a 'light dependent resistor' in some catalogues.

The triac was mounted on a flat heat sink about 1 1/2 in. square. This sink is in contact with the main terminal 2 and requires a suitably insulated mounting.

When the circuitry of Fig. 3 has been completed it may be checked by temporarily fitting PC1 in a cardboard tube, as in Fig. 4. It should be found that the 100 watt lamp lights up when the open end of this tube is directed at sources of light such as windows or room lamps. The 100 watt lamp will light at reduced level

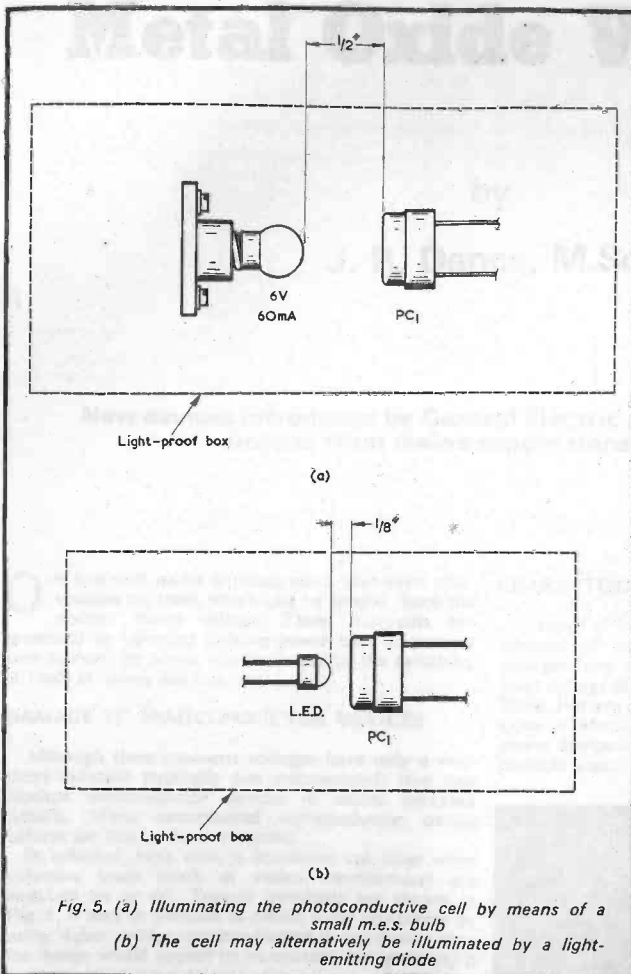

Fig. 5. (a) Illuminating the photoconductive cell by means of a small m.e.s. bulb  
(b) The cell may alternatively be illuminated by a light-emitting diode

when the photoconductive cell is not fully illuminated, and sensitivity should reduce as the slider of VR1 is moved towards the R1 end of the track. It must be remembered that all the components and wiring in Fig. 3, including the photoconductive cell, are at mains potential and that all necessary care must be taken to prevent shock. The test with the photoconductive cell in the temporary cardboard tube is not intended to represent a final method of operation but merely to confirm circuit functioning.

#### CELL ILLUMINATION

Figs. 5 (a) and (b) illustrate the section of the circuit which provides isolated control. This is given by fitting PC1 in a small light-proof box

in company with either a small bulb or a light-emitting diode. Causing either of these to light up will illuminate the photoconductive cell and thereby turn on the triac, and the actuating circuit for the bulb or i.e.d. is, of course, completely isolated electrically from the circuit of Fig. 3 and therefore from the mains.

Constructors may arrange the spacing between the bulb, or i.e.d., and the photoconductive cell to meet their own requirements, but the results achieved by the author will offer a useful guide here.

Fig. 5 (a) illustrates the set-up with a bulb. The bulb employed was a 6 volt 60mA m.e.s. type and it was positioned about 1/2 in. away from the photoconductive cell. The triac turned on fully when a voltage of 3 volts was applied to the bulb. It is

preferable to use a voltage lower than the rated figure for the bulb as the light it emits then drops more rapidly when it is turned off. Even so, there was a just noticeable delay in turn-off of the triac after the supply to the bulb had been removed. The photoconductive cell could contribute slightly to this delay as the increase in resistance it exhibits after cessation of illumination is not immediate. The effect can be controlled to a significant extent by adjustment of VR1.

Fig. 5 (b) shows the arrangement employed with the i.e.d. As illustrated, this is mounted, in its light-proof box, about 1/2 in. away from the ORP12. It was found that the triac operated reliably for forward currents in the i.e.d. from 10 to 30mA. There was apparently less delay in triac turn-off with the i.e.d. than with the bulb.

The i.e.d. employed was a Newmarket NKT7011 (also available from Electrovalue, Ltd.) which has a maximum current rating of 50mA. It was coupled to a battery in the manner shown in Fig. 6. An i.e.d. may only be supplied from a direct voltage, it must be connected up with correct polarity, and it must have a series current limiting resistor. A series resistor of 150Ω will allow an i.e.d. current of approximately 30mA to flow from a 6 volt battery, and a series resistor of 470Ω will allow a current of about 10mA to flow. Since an i.e.d. can be coupled directly to the output of a t.t.l. gate, it follows that the circuit described in this article allows 100 watt lamps to be directly controlled by t.t.l. gates! The existing 10 volt d.c. supply may, incidentally, be employed for more than one control circuit provided that the main terminals 1 of any further triacs that are used connect to the same side of the mains. (Light-emitting diodes and the manner in which they may be coupled to t.t.l.

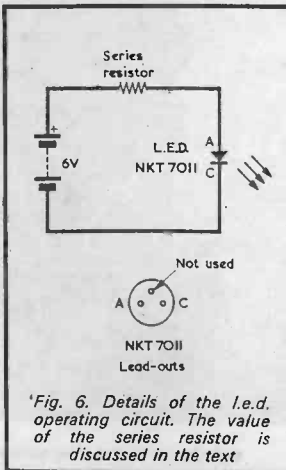

Fig. 6. Details of the i.e.d. operating circuit. The value of the series resistor is discussed in the text

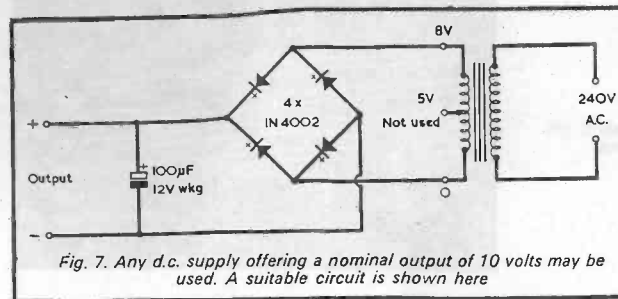

Fig. 7. Any d.c. supply offering a nominal output of 10 volts may be used. A suitable circuit is shown here

gate outputs was discussed in 'Submerged Circuit' No. 268, which appeared in the last March issue.) The d.c. power supply which

produces the 10 volts for the control circuit can be any convenient type, and that used by the author is shown in Fig. 7. It consists quite simply of

a small 8 volt bell transformer (available at Woolworth's stores) feeding a bridge rectifier composed of four silicon diodes and followed by a 100µF reservoir capacitor. No voltage stabilizing was required. The control network will, in practice, work with any supply voltage between 8 and 11 volts.

As a final point, it should be reiterated that all the components and wiring in the control circuit of Fig. 3 are at mains potential. So also are the components which connect to the secondary of the transformer in Fig. 7. All these parts, and their wiring, must therefore be enclosed in an isolated housing and all the relevant safety precautions against shock must be observed.

# NEW EDDYSTONE RECEIVER

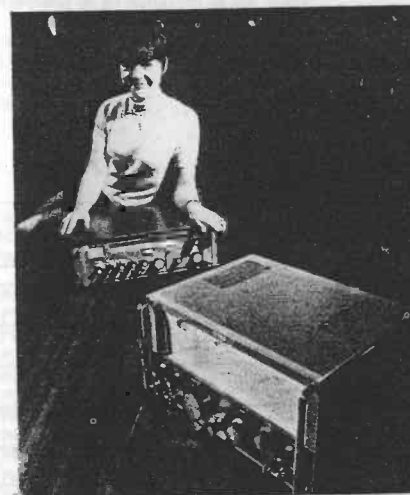

The justly famous Eddystone general purpose valve receiver type 830, shown here in the foreground, is now being phased out of production. Behind it is its successor, the fully solid-state model 1830

AFTER 49 YEARS OF PRODUCTION OF HIGH QUALITY medium-priced valve receivers, Eddystone Radio, now a GEC-Marconi Electronics company, announces that the last of its valved equipments, the world-famous 830 general purpose receiver, is to be phased out of production. It will be replaced by a new, fully solid-state range of receivers, the 1830 Series, designed to meet the operational requirements and budgets of world-wide users on land and sea.

The 1830 Series is basically similar to its predecessor, but provides gapless coverage on c.w., a.m. and s.s.b. from 120kHz to 30MHz and is suitable for mains or 12 volt battery operation. Size and weight have been reduced and versions are available providing up to 50 crystal controlled channels. All models in the Series can be synthesizer-driven.

All variants of the 1830 employ the same basic circuit configuration, using solid-state techniques throughout and following current modular practice. Input protection is provided for the FET/MOSFET front end, which is designed to withstand 30 volts r.m.s. An advanced circuit design is employed, using single-conversion on the low frequency ranges and double-conversion at frequencies above 1.5MHz. The first i.f. is tunable when using double-conversion and provides an incremental tuning facility with a coverage of 50kHz above and below any frequency selected on the main tuning scale. A crystal calibrator is fitted, allowing frequencies to be read to within 1kHz after standardizing the main scale at the nearest 100kHz check point.



# Metal Oxide Varistors

by

J. B. Dance, M.Sc.

New devices introduced by General Electric protect semiconductor circuits from mains supply transient peaks.

OUR ELECTRIC MAINS SUPPLIES HAVE TRANSIENT PEAK voltages on them which can be several times the normal mains voltage. These transients are generated by lightning striking power lines or passing near to them, by power line faults and by the switching of loads at power stations, etc.

## DAMAGE TO SEMICONDUCTOR DEVICES

Although these transient voltages have only a very short duration (typically one microsecond) they can damage semiconductor devices in mains operated circuits. Many unexplained semiconductor device failures are due to these transients.

In addition, high voltage transients can arise when inductive loads (such as mains transformers) are switched on or off. Typical transients are shown in Fig. 1. It may be possible to obtain some protection by using higher voltage semiconductors in equipment than the design would appear to necessitate, but generally it is more convenient to use some form of transient suppressive device.

## THE METAL OXIDE VARISTOR

International General Electric Company of New York Limited have recently added a range of semiconductor devices known as Metal Oxide Varistors to their catalogue. The resistance of such a device remains high until the potential across it rises to a certain value, after which the resistance falls very rapidly with increasing voltage. Metal Oxide Varistors are symmetrical voltage dependent resistors and act like a pair of back-to-back zener diodes. They virtually short-circuit any transient high voltage peaks which may be applied to them.

The devices consist of a ceramic powder which is formed into a disc and placed between two metal electrodes. The whole is encapsulated in an epoxy material.

## CHARACTERISTICS

A range of Metal Oxide Varistors is available for the removal of transients from power supply lines of voltages from around 130 to 1000V r.m.s. The maximum ratings of some of these devices are shown in the Table. For any given r.m.s. voltage rating, there are two types of Metal Oxide Varistor of different maximum power dissipation ratings; the two types have different physical sizes.

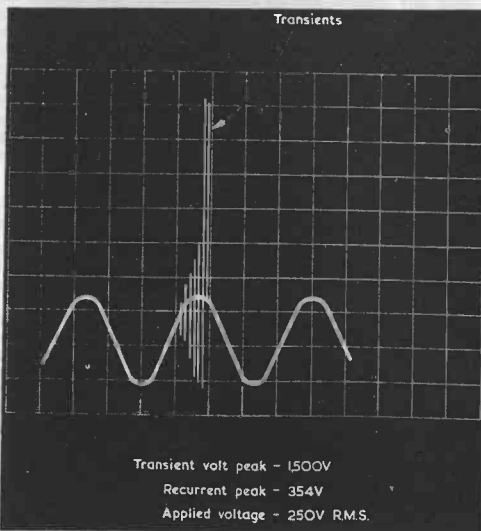

Fig. 1 Typical Transients on a power supply line

RADIO & ELECTRONICS CONSTRUCTOR

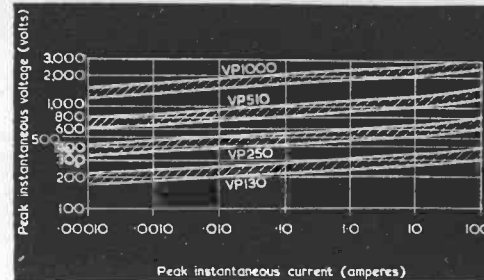

Fig. 2 Voltage-current characteristics of metal oxide varistors of different voltage ratings

The power associated with a voltage transient is dissipated within the Metal Oxide Varistor, but its duration is normally very short, so it does not damage the device.

A Metal Oxide Varistor may be connected across a power line which has a smaller voltage than the voltage rating for which the device is designed, but full protection may not then be obtained.

The voltage-current characteristics of some typical Metal Oxide Varistors are shown in Fig. 2. The width of each shaded band shows the tolerance of the type concerned. Most devices of this type have a capacitance of the order of 500pF, but this value varies somewhat with the applied voltage.

The two type VP250 types are designed for use on power supply lines having a maximum r.m.s. voltage rating of 250. As shown in Fig. 2, typical Metal Oxide Varistors of this type pass about 1mA when the potential across them is 400V (corresponding to a resistance of about 400kΩ), but if the potential across the device reaches 700V a current of about 100A will pass (corresponding to a device resistance of about 7Ω).

The instantaneous voltage-current relationship can be expressed in an equation of the form:

$$I = KV^{\alpha}$$

where K is a constant depending upon the material used in the device and upon its dimensions, whilst a (or alpha) depends on the material and on the manufacturing technique.

The value of a is used as a figure of merit for the devices. The guaranteed minimum value is 25, but it can be as great as 70 in some of the devices. Thus the current passing through such devices is proportional to the voltage to the power of at least 25! Most other transient suppressive devices (such as those employing selenium) have a value for a which does not exceed about 15.

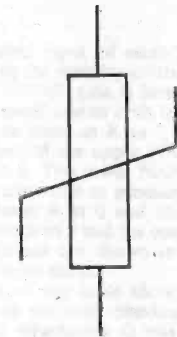

Fig. 3 The symbol for a Metal Oxide Varistor

TABLE  
METAL OXIDE VARISTOR MAXIMUM RATINGS

Varistor Model Number	RMS Input Voltage Volts	Recurrent Peak Voltage Volts	Energy Rating Joules	Average Power Dissipation Rating		Peak Current For Pulses Less Than 7 Microseconds Wide Amperes
				Watts		
VP130A10	130	184	10	0.5	1000	
VP130A20			20	0.85	1250	
VP150A10	150	212	10	0.5	1000	
VP150A20			20	0.85	1250	
VP250A20	250	354	20	0.6	1000	
VP250A40			40	0.9	1250	
VP420B40	420	595	40	0.9	1250	
VP460B40	460	650	40	0.9	1250	
VP480B40	480	679	40	0.7	1000	
VP480B80			80	1.0	1250	
VP510B40	510	721	40	0.7	1000	
VP510B80			80	1.0	1250	
VP1000B80	1000	1414	80	0.9	1000	
VP1000B160			160	1.3	1250	

MAY 1973

The circuit of Fig. 4 shows how a Metal Oxide Varistor may be used in a simple half-wave power supply circuit. It is only necessary to connect a suitable device across the output from the power transformer. No other components whatsoever are required and no changes need be made to the existing circuit.

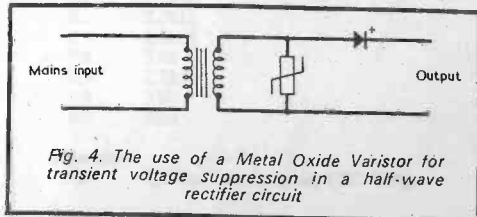

Fig. 4. The use of a Metal Oxide Varistor for transient voltage suppression in a half-wave rectifier circuit

If a full-wave rectifier circuit employing a centre tapped transformer secondary winding is employed, two Metal Oxide Varistors should be used as shown in Fig. 5. A full-wave rectifier bridge circuit using an untapped transformer and four rectifier diodes will require only a single Metal Oxide Varistor across the

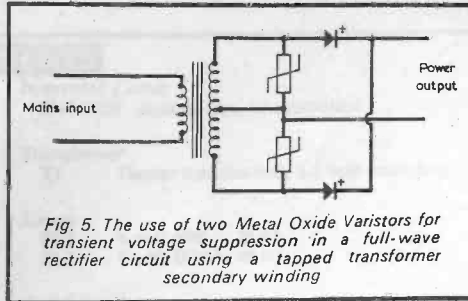

Fig. 5. The use of two Metal Oxide Varistors for transient voltage suppression in a full-wave rectifier circuit using a tapped transformer secondary winding

output of the transformer.

Further details of the Metal Oxide Varistor devices are given in Application Note 200.60 by F. B. Golden and R.W. Fox which is available from International General Electric Company of New York Limited, Lincoln House, 296 High Holborn, London, W.C.1. Stockists of the devices include Jermyn Industries, Vestry Estate, Sevenoaks, Kent.

## RECENT PUBLICATIONS



**110 THYRISTOR PROJECTS USING SCR'S AND TRIACS.** By R. M. Marston. 146 pages, 135 x 215mm. (5½ x 8½ in.). Published by Iliffe Books. Price: hard cover £2.40, limp £1.40.

This is the fifth book by R. M. Marston which describes a quantity of practical projects incorporating semiconductor devices. As the title indicates, the devices in this instance are silicon controlled rectifiers and triacs. Both are considered as being members of the thyristor family.

The book commences with a chapter devoted to operating principles and basic circuits for thyristor and trigger devices, and then proceeds direct to the projects themselves. These include a.c. power switching circuits, electronic alarms, time delay circuits, lamp control circuits, heater control circuits and universal-motor control circuits. The final chapter describes five miscellaneous projects, and is followed by an appendix giving brief details of the semiconductor devices employed in the projects together with their outlines and lead layouts.

Each project is presented as a circuit diagram with descriptive text and its assembly can be undertaken by anybody with a small amount of experience in electronics. An interesting point is that all the semiconductor devices employed are of American manufacture and are available throughout the western world. Mains operated projects are intended both for nominal mains voltages of 120 and of 240 volts. Where this approach necessitates the use of alternative component values or devices, those applicable to 240 volt mains are shown in brackets in the circuit diagrams.

The text is concise and circuit operation is clearly explained in all instances. The book will be of particular interest to both amateur and professional readers, whether or not they have had previous experience with s.c.r.'s or triacs.

**LONG DISTANCE TELEVISION.** 2nd Edition. By Roger W. Bunney. 39 pages, 148 x 210mm. (5½ x 8½ in.). Published by Weston Publishing. Price 50p.

This is a title which is also devoted to a subject that does not normally appear in the world of books. Originally, a pamphlet on TV Dx reception was produced by the author, and this proved to be so popular that it sold out twice. Subsequently, a professionally printed booklet appeared, and this too sold out. The present booklet is the second edition and consists of an expanded version of the printed first edition.

The booklet provides a wealth of useful information for the TV Dx enthusiast. It starts with a summary of world television transmission standards and channel allocations, then proceeds to the various modes of long distance v.h.f. and u.h.f. propagation. Next to be dealt with are receiver requirements including, in particular, the necessity for a low-noise selective tuner. It is interesting to note that the author advocates the use of a valve tuner, as opposed to a bipolar transistor tuner, on v.h.f., and recommends a transistor tuner for u.h.f. Also dealt with, briefly, is colour television. Next follows detailed information on aerials and aerial amplifiers, this including circuits both for v.h.f. and for u.h.f. amplifiers. The circuits are accompanied by coil winding information for v.h.f. amplifiers and by tuned line dimensions for u.h.f. amplifiers. A circuit for a Band I notch filter also appears.

The booklet continues with advice on dealing with interference from local television transmitters, and on photographing received pictures. It concludes with notes on station identification and illustrates 12 test cards for distant transmission systems. There is an acknowledgement to the late Charles Rafarel, who pioneered the hobby of TV Dx and who had been active in this field from the early mechanical scanning systems of the 1930s.

This competent booklet offers much practical information on its specialised subject, and will be an asset to the bookshelves of any enthusiast in the hobby it deals with.

# R-S PRECEDENCE DETECTOR

by R. J. Caborn

An unusual application for an integrated circuit flip-flop.

ONE OF THE BASIC 'BUILDING BLOCKS' OF LOGIC digital circuitry is the R-S flip-flop. This can be made up in several forms, of which one is illustrated in Fig. 1. This diagram shows two 2-input NAND gates with the output of each taken to an input of the other. The inputs are applied at R (for Reset) and S (for Set) whilst the outputs appear at Q and not-Q. The horizontal line above the lower letter Q indicates 'not' and infers that not-Q is the opposite of Q. As we shall see, nevertheless, there is one condition of the R-S flip-flop in which Q and not-Q are the same.

### TRUTH TABLE

The truth table for the R-S flip-flop of Fig. 1 is given in Fig. 2. It will be recalled that the performance of each of the NAND gates which make up the flip-flop is the same as that of an AND gate with its output inverted. With a 2-input NAND gate the output is 1 when either one input or both is at 0. The output falls to 0 only when both inputs are at 1.

Assume first that both the inputs, R and S, of the flip-flop are at 0. Since each NAND gate now has an input at 0, it gives an output at 1. Thus the outputs, Q and not-Q, of the flip-flop are at 1, and this fact is noted in the first line of the truth table. A 1 is passed

to the cross-coupled input of each NAND gate but this does not upset the stability of the circuit because, as just stated, a NAND gate is intended to offer an output at 1 when either one or both of its inputs is at 0.

If we change the input at R to 1, then two 1's are applied to the input of the upper NAND gate and its output changes to 0. The lower NAND gate remains unaffected and it continues to produce an output at 1. Similarly, if we leave R at 0 and change S to 1, the output at not-Q drops to 0 and the output at Q remains at 1. These conditions are shown in the second and third lines of the truth table.

The fourth line of the table shows both R and S inputs at 1. Let us say that, previously, R was at 1 whilst S was at 0, whereupon Q was at 0 and not-Q was at 1. Changing S from 0 to 1 can have no effect on the flip-flop output because the lower NAND gate already has a 0 on the input coupling to the output of the upper NAND gate. The same argument demonstrates that if R was previously at 0 and S was previously at 1, giving Q at 1 and not-Q at 0, the output of the flip-flop remains unchanged if R is changed to 1.

These factors represent the usefulness in digital circuits of the R-S flip-flop. If the inputs change from the second or the third line of the truth table to those shown in the fourth line, the flip-flop 'remembers'

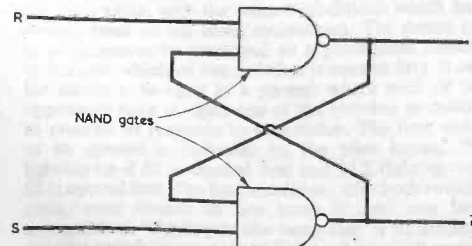

Fig. 1 Two NAND gates interconnected to form an R-S flip-flop

R	S	Q	$\bar{Q}$
0	0	1	1
1	0	0	1
0	1	1	0
1	1	as previous state	

Fig. 2. Truth table for the flip-flop

## COMPONENTS

### Resistors

(All  $\frac{1}{4}$  watt 10%)

R1	2.2k $\Omega$
R2	2.2k $\Omega$
R3	2.2k $\Omega$
R4	33 $\Omega$
R5	2.2k $\Omega$
R6	33 $\Omega$
R7	68 $\Omega$

### Capacitor

C1	1,000 $\mu$ F electrolytic, 10V. Wkg.
----	---------------------------------------

### Semiconductors

TR1	ACY18
TR2	ACY18
D1	4.7 volt 5% 400mW zener diode type BZY88C4V7
D2	IN4002

### Integrated Circuit

SN7400N dual-in-line, or equivalent

### Transformer

T1 Heater transformer, 6.3 volt secondary

### Lamps

PL1 6 volt 60mA, m.e.s.  
PL2 6 volt 60mA, m.e.s.

### Switches

S1 s.p.s.t. toggle  
S2 s.p.s.t. toggle  
S3 s.p.s.t. toggle

### Miscellaneous

14 pin d.i.l. i.c. holder  
2-off bulbholders

the output states which previously existed, and these outputs do not change. If the inputs are changed back from the fourth to the second or third lines of the truth table the flip-flop outputs take up the state indicated for that line. The 'remembering' facility is in one direction only.

The instance shown in the first line of the truth table, in which both flip-flop inputs are at 0, is not commonly encountered in digital applications, and it is customary to ensure that one or other of the two inputs is always at 1. Nevertheless, it is possible to take advantage of R-S flip-flop operation with both inputs at 0, and this is done in the precedence detector circuit which forms the basis of this article.

## PRECEDENCE CIRCUIT

The precedence circuit employs a quadruple dual-input NAND gate type 7400. If the Texas Instruments version of this integrated circuit is employed, it has the type number SN7400N, the suffix 'N' indicating dual-in-line. However, any direct equivalent to the 7400 in dual-in-line may be employed instead. The internal circuitry of the 7400 is shown in Fig. 3 and it will be seen that this comprises four 2-input NAND gates, each coupling to its own set of three terminal

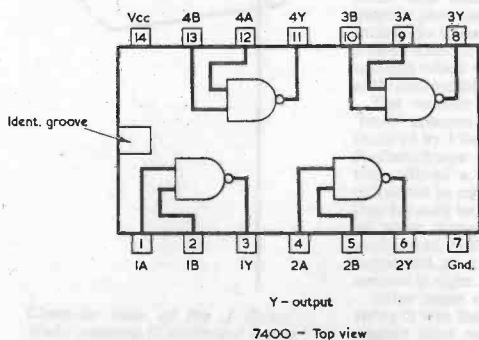

Fig. 3. Pin layout and connections for the dual-in-line i.c. type 7400

pins. The gates are powered by applying a 5-volt supply to terminal pins 7 and 14, the negative line connecting to pin 7 and the positive line to pin 14. The view shown in Fig. 3 is a top view and the i.c. pins point away from the reader.

The circuit of the precedence detector is given in Fig. 4. The secondary of a 6.3 volt heater transformer couples to the half-wave rectifier, D2, which causes a negative voltage to appear on the upper plate of C1. This is dropped to a nominal 4.7 volts by R7 and zener diode D1. This 4.7 volts is applied to the 7400, positive to pin 14 and negative to pin 7.

The 7400 uses positive logic, which means that 1 corresponds to a high (positive) voltage and 0 corresponds to a low (positive) voltage. When circuit operation is described it will be necessary to remember that, unlike conventional logic circuits in which the positive supply rail is the upper line, in Fig. 4 it is the negative supply rail which is uppermost.

The two NAND gates in Fig. 4 which form the R-S flip-flop are those which connect to terminals 1 to 3 and 4 to 6 of the 7400. The negative supply connects to pin 7 and the positive supply to pin 14. No connections are made to pins 8 to 13, and the third and fourth NAND gates of the i.c. are unused.

## CIRCUIT OPERATION

To appreciate circuit operation, assume that S1 and S2 are closed. These cause pin 1 of the upper NAND gate and pin 5 of the lower NAND gate (which pins correspond to the inputs R and S of Fig. 1) to be taken to the negative rail, whereupon these two inputs are at 0 level. The input conditions shown in the first line of the truth table are thus set up, and both outputs, at pins 3 and 6, are at 1. In consequence, the two outputs are at a positive potential which is close to the positive supply rail. Insufficient current flows in R3 and R5 to actuate the transistors TR1 and TR2.

Let us next open switch S1. Pin 1 of the upper NAND gate is then taken to 1 because R2 draws this input towards the positive supply rail. The situation is that shown in the second line of the truth table and the output of the upper NAND gate changes to 0 whilst the output of the lower NAND gate remains unaltered at 1. Since the output of the upper NAND gate is at 0 it is close in potential to the negative (upper) supply

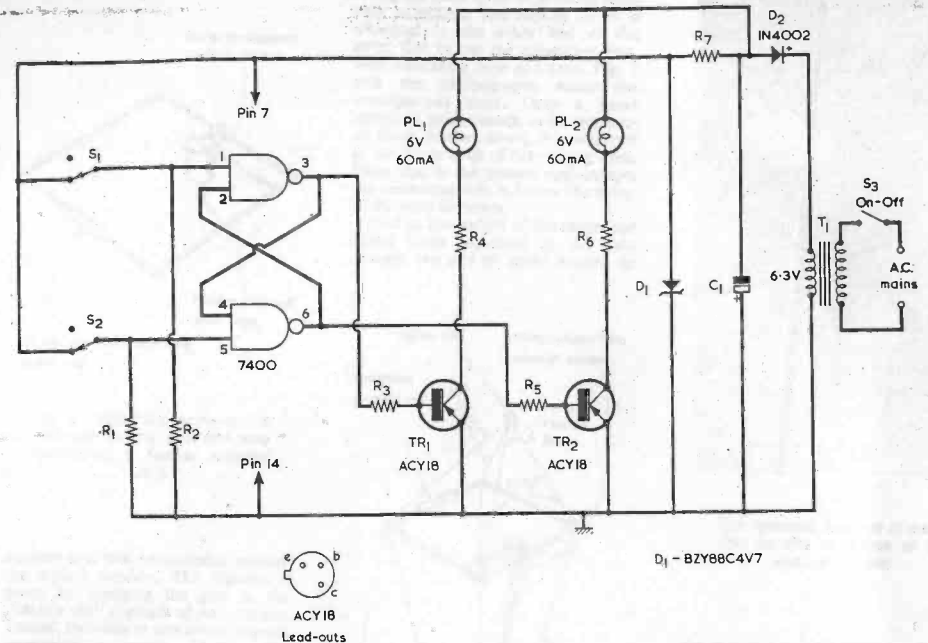

Fig. 4. Complete circuit of the precedence detector

rail and a current flows in R3 and the base-emitter junction of TR1, turning this transistor on and causing PL1 to light up.

If S2 is next opened the input at pin 5 of the lower NAND gate is taken to 1 via R1. However, the flip-flop is already set to its stable state and no change in the illumination of PL1 and PL2 takes place.

If it had been S2 which had been opened first, with S1 closed, the output of the lower NAND gate would have changed to 0, and pilot lamp PL2 would have become illuminated. It would continue to be illuminated, with PL1 extinguished, if S1 had been subsequently opened.

It may be seen that the switching operations just described first take the circuit from the top line of the truth table to either the second or third line according to which of S1 or S2 is opened. Opening the remaining switch merely carries the circuit to the fourth line of the truth table, with the output conditions which have already been set up being maintained. The device can in consequence be employed as a precedence detector to indicate which of two switches is opened first. It can, for instance, be used in a contest where each of two opponents have to open one of the switches as quickly as possible in response to a stimulus. The first switch to be opened is indicated by the pilot lamps, PL1 lighting up if S1 is opened first and PL2 lighting up if S2 is opened first. The final condition, with both switches open, must consist of one lamp lit and one lamp extinguished, whereupon the lamp that is lit indicates the first switch to open, even if the other switch opened only momentarily later. The circuit is returned to its original state by closing both S1 and S2.

The circuit may also have more serious applications,

such as the checking of relay contact operation and the like.

The components in the circuit are all readily obtainable. The mains transformer T1 can be any 6.3 volt heater transformer with a secondary current rating of 0.5 amp or more.

The two resistors R4 and R6 ensure that the voltage across the lamps, when illuminated, is approximately 6 volts. The voltage obtained across C1 is somewhat higher than this figure.

All three switches, including on-off switch S3, may be s.p.s.t. toggle switches. If the constructor is inexperienced in the wiring of integrated circuits he is strongly advised to use an integrated circuit holder. The i.c. is inserted in this holder after the latter has been wired up. To avoid bending of the terminal pins it is recommended that thin flexible wire be employed for the connections to the i.c. holder.

Layout is not important and switches S1 and S2 can, if desired, be positioned some distance away from the remainder of the circuit, being coupled to it by twin flex having lengths of up to some six feet.

It is advisable to ensure that the zener diode is maintaining the desired supply voltage for the i.c. before the latter is inserted into its socket. If the zener diode is connected wrong way round it will act as an ordinary silicon diode and a voltage of 0.6 volt only will appear across it. On the other hand, if the diode is for some reason open-circuit, a voltage of about 8 volts will be applied to the i.c. and this could damage it. With the zener diode specified, a coloured band indicates the end which connects to the positive voltage.



# TWO METRE HALO FOR BOAT USE

by  
Arthur C. Gee, G2UK

How to rig a popular commercially available halo antenna to the crosstree of a yacht.

IN THE OCTOBER 1968 ISSUE OF THIS journal the author described a 2 metre ground plane antenna for use on a yacht.\* This aerial proved quite successful, and it was employed

\*A. C. Gee 'A 2 Metre Ground Plane Antenna', *The Radio Constructor*, October, 1968.

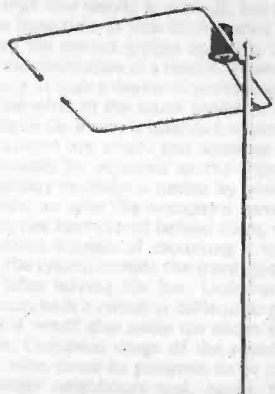

Close-up view of the J Beam Halo antenna. (Courtesy J Beam Engineering Ltd.)

for several years for transmission and reception in the 2 metre amateur band on a yacht based primarily on the Norfolk Broads. Many good QSO's were obtained, particularly with mobile stations using similar vertically polarised aerial systems.

## AERIAL POLARISATION

However, the majority of the local amateur radio stations employ beams with horizontal polarisation. Also, 'halo' antennas are popular with the 'locals' for mobile operation in their cars. The difference in polarisation between the ground plane on the yacht and these other aerals frequently gave rise to poor communication. So ideas were considered for a more suitable antenna for the boat, and one which would give predominantly horizontal polarisation.

The recently introduced J Beam 'Halo' antenna for 2 metres, manufactured by J Beam Engineering Ltd., Rothersthorpe Crescent, Northampton, offered a possible solution. If this could be rigged in such a manner that it could be hoisted in a horizontal plane alongside the mast of the yacht, and with its feeder suitably supported, an answer to the problem seemed in sight.

After some experimentation with string it was found possible to fix up rigging lines which would suspend the halo antenna nicely in a horizon-

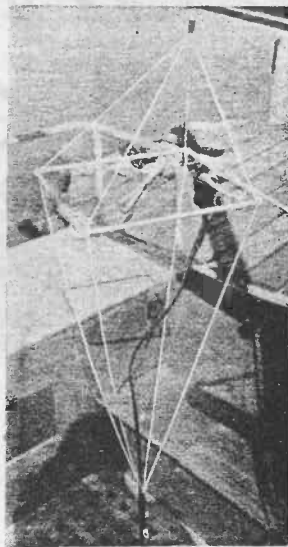

The antenna with its four nylon rigging lines. These are of unequal length to ensure that the halo elements are horizontal

tal plane. Two of the accompanying photographs show the scheme. The Halo antenna (J Beam Cat. No. 2HO) consists of a square of  $\frac{1}{8}$  in. light alloy tubing approximately a foot long on each side. A matching section is coupled to one of the sides together with a waterproof connector box for 75Ω coaxial feeder. There is a gap of about 2 ins. in the opposite side of the square, the ends of the tubing at the gap being sealed with plastic plugs. Fig. 1 shows the configuration.

In the boat application the halo antenna is hung up from its four

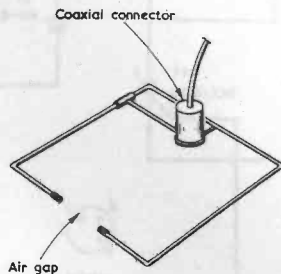

Fig. 1. The basic J Beam Halo antenna

RADIO & ELECTRONICS CONSTRUCTOR

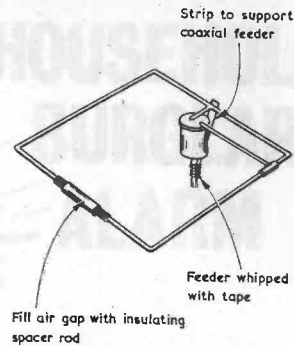

Fig. 2. Fitting a spacing rod to the gap in the antenna and mounting a feeder support strip

corners and this necessitates providing added rigidity. The rigidity is given by bridging the gap in the antenna with a length of polystyrene, Tufnol, Bakelite or any other suitable insulating material. Ideally, the insulating material can be in the form of  $\frac{1}{8}$  in. rod, the ends being filed to a narrower diameter so that they provide a tight push-fit into the ends of the antenna tubing at the gap. The plastic sealing plugs are, of course, previously removed. Fig. 2 shows the idea.

Having strengthened the halo antenna in this way, it is an easy matter to fix rigging lines of suitable length at each corner of the square, using nylon cord which is readily obtainable at yachting stores. Since the halo is to hang horizontally the weight of the coaxial feeder will also have to be supported. A suitable support is provided by a flat strip of insulating material about 6 ins. long by  $\frac{1}{2}$  in. wide and of sufficient thickness to give adequate strength. A hole is drilled at one end, through which the bolt normally intended for

fixing the halo to its supporting mast may be passed. The coaxial feeder is whipped to the other end of the strip, just below the connector box, with insulating tape and cord. Fig. 3 and the photographs make the arrangement clear. Only a short length of feeder needs to be supported since, further down, it is whipped to the lower ends of the rigging lines. Note that in the present application, the connector box is below the plane of the halo elements.

Due to the weight of the feeder the nylon cords attached to the halo corners are not of equal length. In

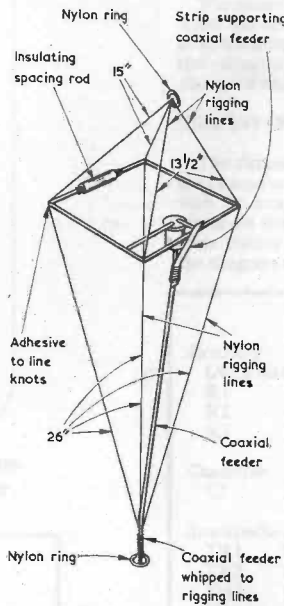
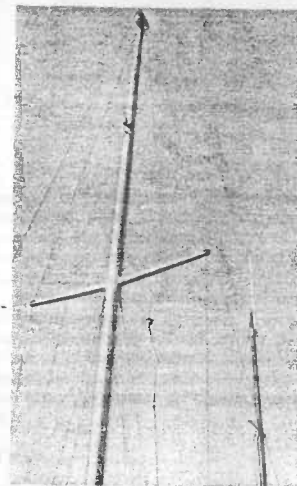

Fig. 3. How the antenna is rigged. The lines above the antenna are of unequal length in order to take up the weight of the coaxial feeder and, thus maintain the antenna in a horizontal plane



The antenna hoisted in position to the crosstree of the author's yacht

the author's case the cord length from the two corners nearest the coaxial connector to the top fitting was  $13\frac{1}{2}$  ins., and the length from the other two corners to the top fitting were 15 ins. The lengths of cord from the four corners to the bottom fitting were all the same, being approximately 26 ins. Their lower ends are whipped to the coaxial cable with insulating tape and cord.

The top and bottom fittings just referred to are small nylon rings,  $\frac{1}{4}$  in. in diameter, and the hoisting hal-yards are secured to these. A drop of adhesive applied to the centres of the knots at the halo corners will ensure that these do not slip.

This arrangement has enabled the halo antenna to be hoisted up to the crosstree in the writer's boat in a most convenient manner and in such a way that it does not get fouled up on adjacent rigging. Results in use have been very satisfactory indeed. ■

## BACK NUMBERS

For the benefit of new readers we would draw attention to our back number service.

We retain past issues for a period of two years and we can, occasionally, supply copies more than two years old. The cost is the cover price stated on the issue, plus 6p postage.

Before undertaking any constructional project described in a back issue, it must be borne in mind that components readily available at the time of publication may no longer be so.

We regret that we are unable to supply photo copies of articles where an issue is not available. Libraries and members of local radio clubs can often be very helpful where an issue is not available for sale.

MAY 1973



# HOUSEHOLD BURGLAR ALARM

by  
R. J. Caborn

THE BURGLAR ALARM SYSTEM DESCRIBED IN THIS article is intended for installation in small domestic residences in which no articles of great value are retained. Premises of this nature will not normally merit the attentions of the skilled thief and are more likely to be broken into by the less sophisticated type of villain. Because of this, and also to reduce initial and running expenses, simplifications in operation have been incorporated which result in a system that may not be 100% proof against the fully seasoned burglar but which nevertheless offers a high level of protection at low cost.

The prototype was constructed for the protection of a flat when its occupants were away, and it was designed to cause a bell to sound continually after the actuation of one or more switches. Burglars do not like noise, and a continually ringing bell would attract the attention of neighbours.

## SWITCHING SYSTEM

To be operable at all times a burglar alarm has to be independent of the mains supply, and this means that it has to function from batteries. The question of mode of operation immediately follows, since a choice has then to be made between a system which is activated when a circuit is broken by the intruder and one which is activated when a circuit is completed.

The first of these two modes is obviously the more reliable because it ensures automatic sounding of the alarm when any wire in the system is cut. On the other hand, it requires the continual flow of a current through the system which, to overcome leakage resistance at switching points and to offer robustness of action, needs to have a level of at least several milliamps. Such a current flow results in a small, but significant, expenditure from time to time on batteries. Because of this last point the present system operates, in the second mode, on the completion of a circuit. Nevertheless, it still offers nearly as high a degree of protection against the cutting of the wires to the alarm switch or switches.

Since the alarm is intended to protect a flat when the occupants are away, and since an alarm switch must obviously be mounted at the front door, it becomes necessary to devise a means by which the alarm can be turned on *after* the occupants have left and the front door has been closed behind them. One solution to this problem consists of mounting a hidden on-off switch for the system outside the front door, this being turned on after leaving the flat. Unfortunately, in many instances such a switch is difficult to position successfully and it would also make the alarm system more vulnerable. Continual usage of the switch by the occupants will soon cause its presence to be common knowledge amongst neighbours and, again, there is the risk of tampering by children. The system to be described here uses an alternative approach; after the alarm has been switched on a period of about four minutes elapses before it becomes effective, this giving the occupants

Incorporating reliable circuit techniques, this burglar alarm system offers a high level of protection to the flat dweller or householder.

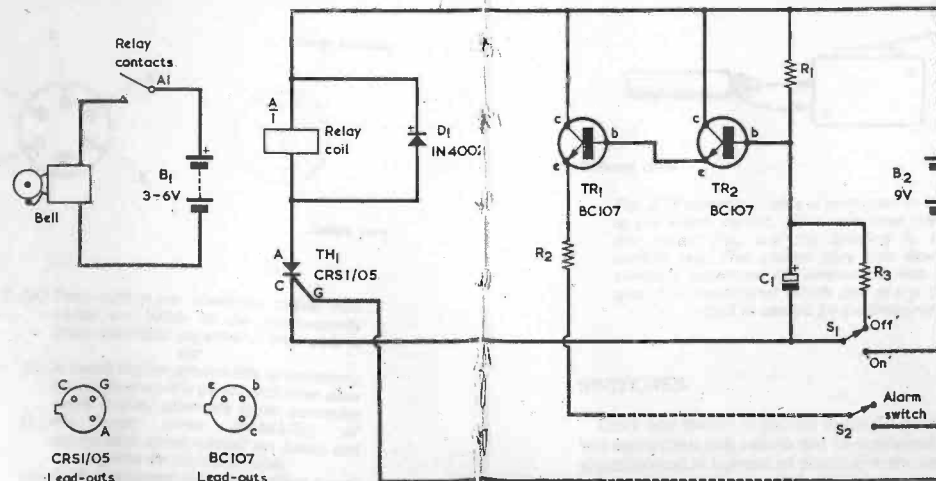

Fig. 1. The circuit of the burglar alarm. The bell rings continuously immediately S2 is closed or the wires to it are short-circuited

plenty of time to close the front door and thereby open the alarm switch fitted at that door. The only disadvantage with the present method is that the occupants will cause the alarm to sound when they themselves return; but it can soon be silenced by means of its own switch inside the premises, and the location of this switch will be known to the occupants only.

The alarm can also, of course, be turned on for use when the occupants are at home and asleep. The entry of an intruder will then cause the bell to sound and waken the occupants in the normal manner associated with alarms of this nature.

## CIRCUIT OPERATION

The circuit of the alarm system appears in Fig. 1. All the components shown here are situated at one location with the exception of the alarm switch, S2. This switch closes on the entry of a burglar, and is coupled to the main circuit by a pair of wires which are illustrated in the diagram as broken lines.

## COMPONENTS

- Resistors**  
(All  $\frac{1}{2}$  watt 10%)  
R1 470k $\Omega$   
R2 470 $\Omega$   
R3 33 $\Omega$

- Capacitor**  
C1 1,000 $\mu$ F electrolytic, 10 V. Wkg.

- Semiconductors**  
TR1 BC107  
TR2 BC107  
TH1 CR51/05  
D1 1N4002

- Switches**  
S1 s.p.d.t. toggle  
S2 Alarm switch (see text)

- Batteries**  
B1 3 to 6 volt battery  
B2 9 volt battery

- Bell**  
Low voltage electric bell

- Relay**  
Coil resistance 200 $\Omega$  or more (see text)

- Miscellaneous**  
Lektrokit Chassis Plate No. 1, Part No. LK-111  
3-off 5-way tagstrips, centre earthed  
1-off 8-way terminal strip  
Battery connectors (as required)  
Connecting wire for alarm switch circuit (see text)

The alarm is switched on by changing S1 from 'Off' to 'On'. The 9 volt battery, B2, is then coupled to R1 and C1 in series, and C1 commences to charge slowly. The potential on its positive plate is passed to the base of TR2 which, with TR1, forms a compound emitter follower pair. A gradually increasing potential appears at the emitter of TR1 as soon as the voltage across C1 exceeds 1.2 volts and thereby overcomes the base-emitter drop of 0.6 volt in each transistor. The voltage at the emitter of TR1 continues to rise as C1 charges.

The emitter of TR1 couples via R2 and the alarm switch S2 to the gate of the thyristor TH1. When the voltage at TR1 emitter is sufficiently high, closing S2 will cause a current to pass to the thyristor gate, thereby turning it on. The conducting thyristor energises relay A, whose contacts close and cause the bell to sound. Once it has been triggered the thyristor remains conductive even if S2 opens again, and the bell continues to ring until the supply to the thyristor via the relay coil is broken by returning S1 to the 'Off' position. The relay then releases, the bell ceases to sound, and capacitor C1 is rapidly discharged via current limiting resistor R3. The system is then ready for the next period of operation.

At first sight, there may appear to be needless complications in the circuit of Fig. 1. Using the same basic principles it would be feasible to dispose with all semiconductor devices and simply have a circuit in which C1, when sufficiently charged, is connected directly across the relay coil via S2. The relay could then be retained in the energised condition after S2 closes by means of an extra pair of latch-on contacts which connect it directly across the 9 volt supply. However, the energising of the relay would not be instantaneous and, for reasons which are discussed later, it is desirable for the circuit to operate after even a momentary closure in the S2 circuit. In consequence, the thyristor TH1, which offers instantaneous triggering, is incorporated.

Again, it would be possible to dispense with TR1 and TR2 and to couple the positive plate of C1 direct to R2. If after C1 had become sufficiently charged S2 was closed, the discharge current flowing in the gate of TH1 could, theoretically at any rate, trigger the thyristor and sound the alarm. However, such an approach would not cater for the instance where S2 happens to become closed before sufficient charge has appeared in C1 to trigger the thyristor. (This state of affairs could occur if someone broke into the protected flat very shortly after its occupants had left.) All that would happen then would be that the capacitor would discharge via R2 into the gate of the thyristor, and there would be insufficient current available through R1 to fire the thyristor. Further, the alarm system would be rendered inoperative. When TR1 and TR2 are added, virtually all the gate current for TH1 is provided by way of TR1, and negligible current is drawn from the positive rail via R1 or from the charge in the capacitor. With the circuit as it stands, operation is automatic under all conditions. If S2 is closed after the delay period has elapsed the bell rings immediately. Similarly, if S2 is closed before the finish of the delay period the bell starts to ring as soon as the delay period ends. It is felt that the automatic protection given here is well worth the addition of two inexpensive transistors.

A final point concerns the use of a relay, which is a somewhat 'old-fashioned' device, to operate the bell. It might be assumed that TH1 could turn on the bell directly, or that it could turn on another thyristor having a higher current rating, or a power transistor, which in its turn would switch on the bell. However,

it has to be pointed out that electric bells, including in particular the cheap models available at the popular stores, form a difficult load for a semiconductor switching device to cope with. Inexpensive bells have armature pull-in currents in excess of an amp, draw a continually interrupted current and produce high voltage inductive spikes. These factors still do not, of course, prevent a bell being turned on by means of a semiconductor device, and experimenters may care to develop a version of the present circuit using such a device to control the bell. The author's feelings were that the best way of switching on the bell was to isolate it from the electronics completely and, in consequence, he incorporated the relay shown in the diagram. Bell operation is quite straightforward and reliable, and the relay type required is not at all critical.

### INSTANT OPERATION

Mention has been made in the foregoing of the desirability for the circuit to be triggered instantaneously by closure of the S2 circuit, this being the reason for including the thyristor in the circuit. As will now be explained, instant operation provides a high level of protection against the wires in the S2 circuit being cut.

One method of connecting the main part of the circuit to S2 is by way of flexible 2-core cable having a cross-section of the nature shown in Fig. 2 (a). This type of

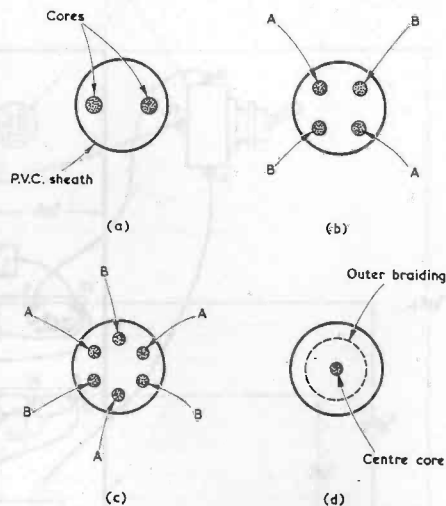

Fig. 2. (a) Two-core p.v.c. sheathed cable. The cores are liable to be momentarily short-circuited together if the cable is cut  
(b) A much higher probability of momentary short-circuit is given with four-core cable having alternate cores common  
(c) An even greater probability of momentary short-circuit on being cut is given by six-core cable  
(d) Audio screened cable also offers a very high probability of momentary short-circuit when cut

RADIO & ELECTRONICS CONSTRUCTOR

cable is sheathed in round section p.v.c. and it is not possible to determine by external visual examination where the individual wires lie inside the sheath. Cable of this nature has to be cut with metal snips or pliers, and it is quite probable that these will momentarily short-circuit the two cores together as the cable is cut. The momentary short-circuit is all that is needed to fire the thyristor and set off the alarm.

A higher probability of momentary short-circuit is given by the use of 4-core cable, as in Fig. 2 (b), and an even higher probability by 6-core cable, as in Fig. 2 (c). In both cases alternate cores inside the cable connect to the opposite sides of the switch circuit. Thus, the cores marked 'A' could correspond to the upper dashed line in Fig. 1 and the cores marked 'B' could correspond to the lower dashed line. It would be difficult to cut either of these two cables without momentarily short-circuiting at least two of the alternate cores together and thereby triggering the thyristor.

Smooth plastic sheathed 4-core or 6-core cable is a little difficult to obtain and may prove expensive. Another alternative for the alarm switch wiring consists of plastic covered flexible screened wire, as employed for a.f. coupling between hi-fi units. This has the cross-section shown in Fig. 2 (d) and may be connected to switch S2 in the manner shown in Fig. 3. Once again, there is a high probability of a momentary short-circuit when this type of wire is cut. The author experimentally connected a length of a.f. screened wire to the prototype alarm circuit and checked whether he could cut it without triggering off the alarm. Despite continued attempts, he found it impossible! The screened wire used had a fairly thick outer braiding. Television aerial coaxial cable was also checked, but this did not always give a momentary short-circuit when cut because of the thinness of both the outer braiding and the centre conductor and because of the wide spacing between them. Coaxial cable is not, therefore, suitable for the S2 wiring.

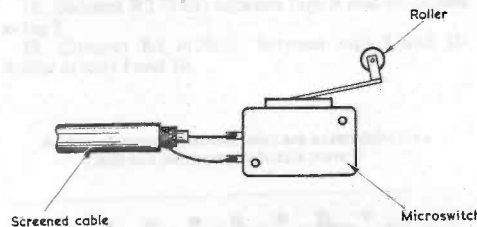

Fig. 3. If screened cable is employed in the wiring to the alarm switch, the centre core connects to one switch tag and the braiding to the other switch tag. The centre core and braiding are similarly separated for connection into the main unit. It is immaterial which side of the switching circuit is carried by the braiding

### SWITCHES

Only one switch is shown in the S2 position in Fig. 1 but more than one switch can be employed. Each switch is positioned at a point of possible entry and all switches are connected in parallel. The use of suitable wire coupling to these switches offers a high level of protection against wire-cutting at all points except those where

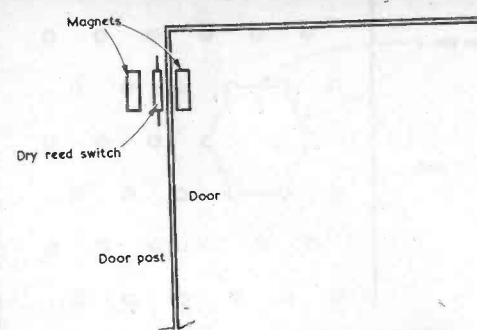

Fig. 4. How a dry reed switch can be fitted to a door-post so that its contacts close when the door opens. The magnets have opposite polarity, and their fields cancel out at the switch when the door is closed

the two conductors of the wire separate to connect to the switch contacts. If it is deemed necessary, the wires will have to be covered physically at the switch or switches.

A microswitch was used with the prototype alarm, this being operated by the opening of the front door. It had an extension arm with a roller at the end, similar to the Home Radio microswitch Cat No. WS104 fitted with an 'operator attachment' Cat. No. WS108. A suitably shaped piece of metal fitted to the door pressed on the roller and opened the switch when the door was closed.

Dry reed switches could also be used. These are normally-open devices which close on the application of a magnetic field. They can be used in the manner shown in Fig. 4, which illustrates a reed switch fitted to a doorpost, at the side opposite to the door hinge, and with a magnet fixed alongside it. A second magnet, with opposing polarity, is secured to the door. When the door is closed the fields from the two magnets cancel out and the switch remains open. When the door is opened the switch comes under the influence of the single magnet alongside it, and its contacts close. A similar type of installation can be made at a window (provided it does not have a steel frame, which will absorb the fields from the magnets). In this case the first magnet and dry reed switch are attached to the window frame, and the second magnet to the window itself. A suitable dry reed switch is the R.S. Components 6RSR (Home Radio Cat. No. WS120) for which the requisite magnet is the Home Radio Cat. No. WS124.

### COMPONENTS

The components required for the circuit of Fig. 1 are quite standard and should not be difficult to obtain. The relay may be any component, other than a dry reed type, having a coil resistance of 200Ω or more and which is capable of energising reliably at a voltage of some 7 volts. This takes in a very wide range of relays, including the Home Radio Cat. No. Z70A. Only one normally-open contact set is required. If the relay has more contacts, those remaining may be ignored. The relay used in the prototype was a P.O. 3000 type with a coil resistance of 500Ω.



Diode D1 is included to prevent the appearance of a high back-e.m.f. voltage across the relay coil when the relay releases. Any small silicon rectifier may be used here, the type employed in the prototype being a 1N4002. Switch S1 is a s.p.d.t. toggle component.

The electrolytic capacitor, C1, should be a good quality modern component. It may have a higher working voltage than the 10 volts specified if a 10V Wkg. component cannot be obtained.

The voltage of battery B1 lies between 3 and 6 volts according to the requirements of the bell. A fairly large battery is desirable since, as was noted earlier, some bells require a relatively heavy current. The current drawn from battery B2 when the alarm is switched on but not triggered is very small, being typically less than 20µA. This rises to around 14mA plus the relay coil current when S2 closes and activates the alarm. A PP9 battery should be more than adequate here and will give a long life.

The layout of the components required for the burglar alarm is not critical and constructors may assemble them in any manner they prefer. The prototype was made up on a Lektrokit perforated chassis plate and this has the advantage of reducing metal-work to a minimum. The constructional details which follow

apply to this method of assembly. When making up the unit in this way it is necessary to obtain a Lektrokit Chassis Plate No. 1, Part No. LK-111. This is available from Home Radio under the same Cat. No. Also required are three tagstrips with the centre tag functioning as a mounting lug. These should be approximately 1½ in. in length, and the type employed in the prototype was Home Radio Cat. No. BTS34H. Finally needed is an 8-way terminal strip. This is cut down from a longer strip available from the electrical counter in Woolworth's stores, and the type employed may be identified from the accompanying photographs of the unit.

### CONSTRUCTION

A layout and wiring diagram is given in Fig. 5, and assembly is described in the following step-by-step instructions. Note that no joint should be soldered unless expressly stated; this prevents soldering twice at any junction. Where convenient, insulated wires may pass under tagstrips in the interest of neatness. The tags in Fig. 5 are given numbers for reference purposes.

1. Cut out a hole for switch S1 at the upper right-hand corner of the chassis plate. The hole may be made by cutting away the metal between existing holes, as shown

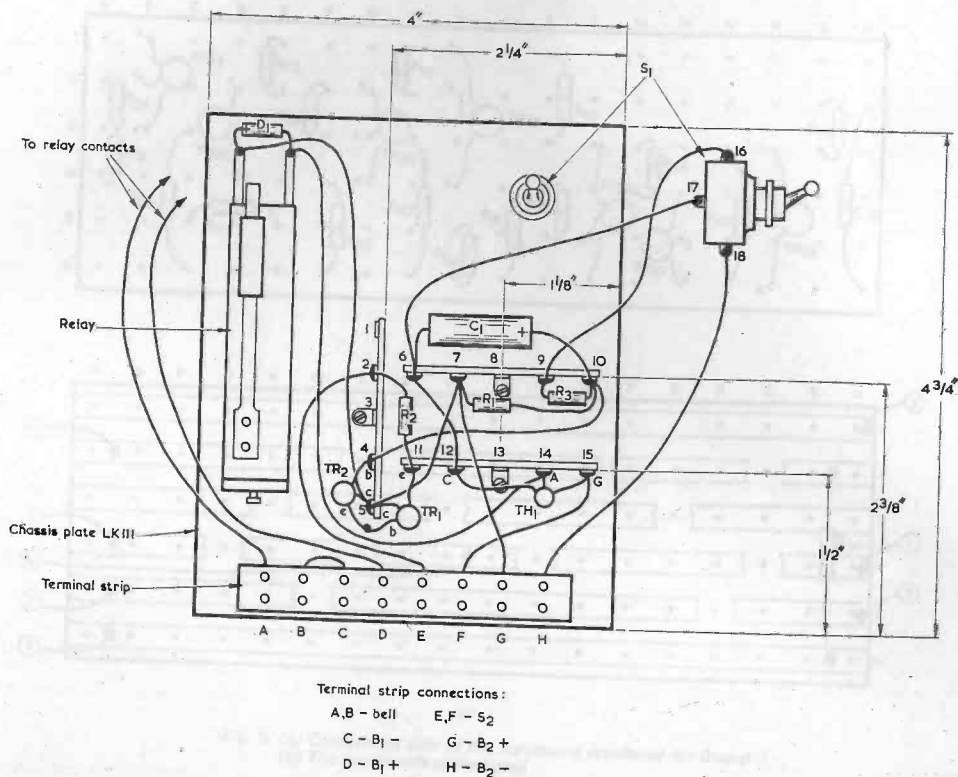

Fig. 5. Wiring and component layout of the prototype unit

in Fig. 6, with the aid of a pair of side-cutters or snips. Any rough edges resulting can be smoothed off with a file. Mount S1. (This is shown in two positions in Fig. 5 for purposes of illustration.)

2. Using 6BA bolts and nuts, mount the three tagstrips in the approximate positions indicated in Fig. 5. Precise positioning is not important.

3. Using 6BA bolts and nuts, mount the 8-way terminal strip at the bottom of the chassis plate by means of any two holes in the strip which coincide with holes in the chassis plate.

4. Mount the relay. The manner in which this is fitted depends upon the relay employed. Fig. 5 assumes a P.O. 3000 relay.

5. Connect an insulated wire between terminal H and tag 18 of S1, soldering at tag 18. This wire passes through any convenient hole in the chassis plate, as do the other two wires which pass to the switch tags.

6. Connect an insulated wire between tag 6 and tag 17 of S1, soldering at tag 17.

7. Connect an insulated wire between tag 9 and tag 16 of S1, soldering at tag 16.

8. Connect an insulated wire between terminal G and tag 7.

9. Connect an insulated wire between terminal F and tag 15.

10. Connect an insulated wire between tags 6 and 12.

11. Connect an insulated wire between tags 4 and 10.

12. Connect an insulated wire between tags 5 and 7.

13. Connect an insulated wire between tags 5 and one coil tag of the relay. Connect the positive lead-out of D1 to this coil tag and solder at the coil tag.

14. Connect an insulated wire between tag 14 and the remaining coil tag of the relay. Connect the negative lead-out of D1 to this coil tag and solder at the coil tag.

15. Connect an insulated wire between terminal E and tag 2.

16. Connect the negative lead-out of C1 to tag 6. Solder at tag 6.

17. Connect the positive lead-out of C1 to tag 10.

18. Connect R3 (33Ω) between tags 9 and 10. Solder at tag 9.

19. Connect R1 (470kΩ) between tags 7 and 10. Solder at tags 7 and 10.

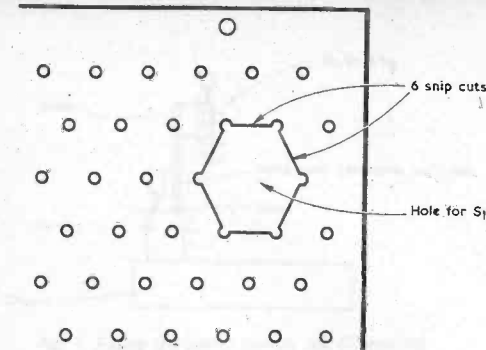

Fig. 6. A simple means of providing a mounting hole for switch S1

20. Connect R2 (470Ω) between tags 2 and 11. Solder at tag 2.

21. Take up TH1 and connect its cathode (C) to tag 12, its anode (A) to tag 14 and its gate (G) to tag 15. Solder at tags 12, 14 and 15.

22. Take up TR1 and connect its emitter to tag 11 and its collector to tag 5. Solder at tag 11.

23. Take up TR2 and connect its base to tag 4 and its collector to tag 5. Solder at tags 4 and 5.

24. Join the emitter of TR2 to the base of TR1 and solder. This joint is not supported by a tag.

25. Connect an insulated wire between terminals B and C.

26. Connect an insulated wire between terminal D and one of the relay contact tags. Solder at the relay contact tag.

27. Connect an insulated wire between terminal A and the remaining relay contact tag. Solder at the relay contact tag.

Wiring up of the components on the chassis plate is now complete. The plate can be mounted in any convenient manner, such as with long wood screws passed through two or more of the available holes. Spacing pillars may be employed to provide clearance for the body of S1 behind the plate.

28. Connect an insulated wire between terminal A and the remaining relay contact tag. Solder at the relay contact tag.

29. Connect an insulated wire between terminal A and the remaining relay contact tag. Solder at the relay contact tag.

30. Connect an insulated wire between terminal A and the remaining relay contact tag. Solder at the relay contact tag.

31. Connect an insulated wire between terminal A and the remaining relay contact tag. Solder at the relay contact tag.

32. Connect an insulated wire between terminal A and the remaining relay contact tag. Solder at the relay contact tag.

33. Connect an insulated wire between terminal A and the remaining relay contact tag. Solder at the relay contact tag.

34. Connect an insulated wire between terminal A and the remaining relay contact tag. Solder at the relay contact tag.

35. Connect an insulated wire between terminal A and the remaining relay contact tag. Solder at the relay contact tag.

36. Connect an insulated wire between terminal A and the remaining relay contact tag. Solder at the relay contact tag.

37. Connect an insulated wire between terminal A and the remaining relay contact tag. Solder at the relay contact tag.

38. Connect an insulated wire between terminal A and the remaining relay contact tag. Solder at the relay contact tag.

39. Connect an insulated wire between terminal A and the remaining relay contact tag. Solder at the relay contact tag.

40. Connect an insulated wire between terminal A and the remaining relay contact tag. Solder at the relay contact tag.

41. Connect an insulated wire between terminal A and the remaining relay contact tag. Solder at the relay contact tag.

42. Connect an insulated wire between terminal A and the remaining relay contact tag. Solder at the relay contact tag.

43. Connect an insulated wire between terminal A and the remaining relay contact tag. Solder at the relay contact tag.

44. Connect an insulated wire between terminal A and the remaining relay contact tag. Solder at the relay contact tag.

45. Connect an insulated wire between terminal A and the remaining relay contact tag. Solder at the relay contact tag.

All the electronic components are assembled on a Lektrokit perforated chassis plate

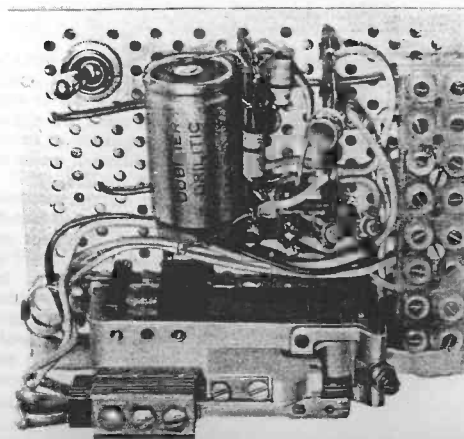

# MODIFICATIONS

## TO

# CYCLOPS

Part 2

by L. C. Galitz

This article concludes our 2-part series and describes the construction of the modifications which enable Cyclops to exhibit further reflex actions.

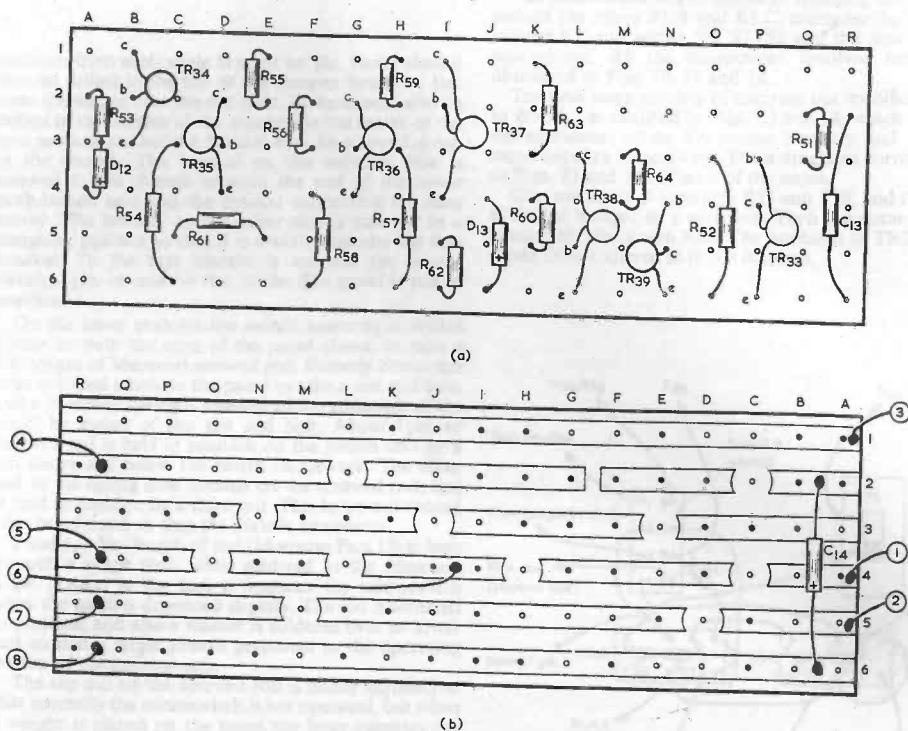

Fig. 5. (a) Component side of the veroboard employed for Board 3  
(b) The copper side of the board

## CONSTRUCTION

FIRSTLY, THE NEW BOARD HAS TO BE ASSEMBLED AS shown in Figs. 5(a) and (b), which illustrate the component and copper sides respectively. The board has a matrix of 0.15in., and has 6 strips with 18 holes each. The strips are cut as indicated in Fig. 5(b). Note that there is a break between F2 and G2 which is made with a knife, as opposed to the more usual method of cutting the strip at a hole.

It will probably be found most convenient to fit the following components vertically rather than horizontally: R53, D12, R61, R55, R56, R59, R62, R60, R64, R51. Note that the junction between R53 and the negative end of D12 is made above the board and not at any of the copper strips.

The circled numbers, from 1 to 8, in Fig. 5(b) show the plug pin numbers to which the various circuit points connect. The appropriate connections are listed also in Table II. If an 8-way plug is not employed the number references still apply so far as external connections to the board are concerned. Capacitor C14 is wired on the copper side of the board.

The new board is positioned above relay RLB, its socket being secured to the bracket which retains the relay in position. See Fig. 6. If a socket is not used, a

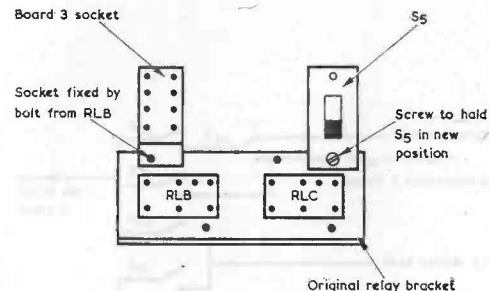

Fig. 6. Mounting S5 in its new position. Also shown is the socket for Board 3 employed in the prototype. Alternative sockets may have a different appearance and require other methods of mounting

suitable means of mounting should be devised. In this respect it may be mentioned that it would be helpful here to use a board that is longer than .18 holes. The additional holes may be isolated from the rest of the board by cutting the strips, and the extra section drilled to take a mounting bracket.

Next, S5, the paralyse switch, which was originally mounted at the side of the push button unit S1-S4, should be moved to the back of the robot and mounted on the relay bracket along with the new board as in Fig. 6. Then the new push-button unit can be mounted. In the author's case, the switch was mounted by soldering two rods on top of the existing switch, and soldering the new switch to the rods, as in Fig. 7. However, there is plenty of room between the front of the robot and Board 2, and the new switch may be mounted there if preferred.

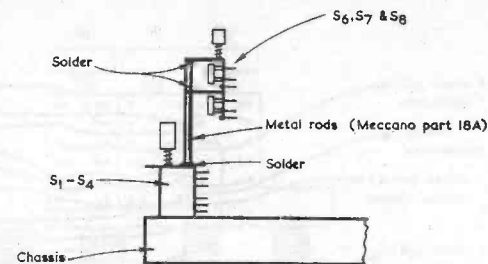

Fig. 7. Fitting the added switch, S6, S7 and S8

The two brackets for the load-carrying mechanism are made of Perspex, since they would otherwise obstruct the path of external light reaching Cyclops' eye. In the prototype the panel on which loads are placed was also made of Perspex. However, since the panel is above the level of the eye, any other suitable material could be employed instead.

The brackets are made 6 1/2in. long and 1/2in. wide. They are bent 1/4in. from one end by gently heating the position to be bent over a flame or over an electric cooker hot plate. After the area is hot, the strip is bent by folding the last 1/4in. around a right-angled bench top or the like. Figs. 8 and 9 give details of the load-carrying mechanism.

The panel is cut 6 1/2in. wide by 6 1/2in. long out of the chosen material and, 1/4in. from the front and 1/4in. from each side, holes are drilled to take a nut and bolt. Two Meccano angle brackets are screwed to the panel at these points. A rod is passed through the two brackets parallel to the surface of the plate, and soldered in place. The rod should be 7in. long, made from a Meccano No. 13a 8in. rod cut to size, and the rod should

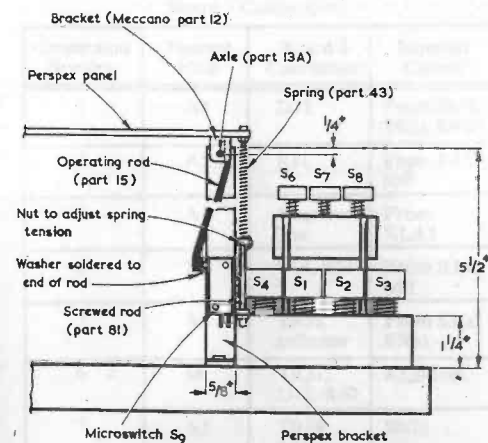

Fig. 8. The load-sensing assembly. When a load is placed on the Perspex panel this moves down slightly, against the tension spring, and operates the microswitch

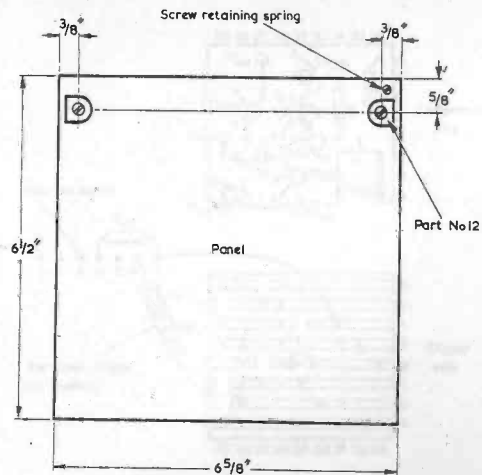

Fig. 9. Details of the Perspex load-carrying panel

protrude from each angle bracket by  $\frac{1}{8}$  in. Holes should then be drilled in the top of the Perspex brackets,  $\frac{1}{8}$  in. from the top, to take the rod ends. Holes should also be drilled in the bottom of the brackets in the centre of the bent section, so that the bracket may be screwed down to the chassis. The bracket on the switches side is screwed to the chassis between the end of the lower push-button unit and the bracket supporting the scan motor. The bracket on the other side is screwed in a matching position so that it is exactly opposite the first bracket. To the first bracket is screwed the microswitch,  $1\frac{1}{2}$  in. up and on the inside. The panel is put in position.

On the lower push-button switch assembly is drilled a hole beneath the edge of the panel above, to take a 2 in. length of Meccano screwed rod. Directly above this hole is drilled a hole in the panel to take a nut and bolt, and a Meccano spring is screwed to the underside of the panel by means of this nut and bolt. About  $1\frac{1}{2}$  in. of screwed rod is held in position on the switch unit by a nut above and below the switch framework. The other end of the spring now threads on the screwed rod, and is held in position by a third nut. This latter nut should now be adjusted so that the plate is horizontal.

Finally, a 5 in. length of rod (Meccano Part 15) is bent to such a shape that, when soldered to the Meccano angle bracket at the top, it operates the microswitch when the panel is depressed slightly. The rod is soldered in position, and also a washer is soldered over its lower end so that a larger area is presented to the operating button of the microswitch.

The top nut on the screwed rod is finally adjusted so that normally the microswitch is not operated, but when a weight is placed on the panel the lever operates the microswitch. The spring should provide sufficient tension to return the microswitch to the off position when the load is removed.

It may happen that due, maybe, to a differing switch system, the microswitch details just given cannot be applied to a particular version of Cyclops. An alterna-

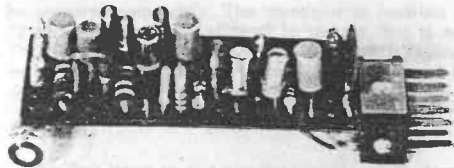

The appearance of the completed Board 3. Note that C14 is at the top, away from the plug end

tive position for the microswitch is just under the panel away from the hinged end (i.e. at the back of Cyclops) so that the panel operates the microswitch directly.

The next stage is to add the new noise suppression capacitors C11 and C12. The former is soldered between the positive end of RLB coil and the positive line on the new board. See Fig. 10. C12 is soldered directly between pins 2 and 4 of the socket holding Board 2.

The penultimate stage consists of changing the wiring around the relays RLB and RLC, changing the wiring around S3, and wiring S6, S7, S8 and the new board into circuit. All the connections involved here are illustrated in Figs. 10, 11 and 12.

The final stage consists of carrying out modifications to Board 2 as outlined in Figs. 13 and 14, which shows the alterations to the En output circuitry and the Ss input circuitry respectively. These diagrams correspond to Figs. 33 and 34 in Part 6 of the series.

Cuts are made at locations B25 and F29, and the cut at D29 is bridged by a wire link. Then transistor TR32 is inserted, along with R50. The positions of TR28 and diode D8 are altered as in the diagram.

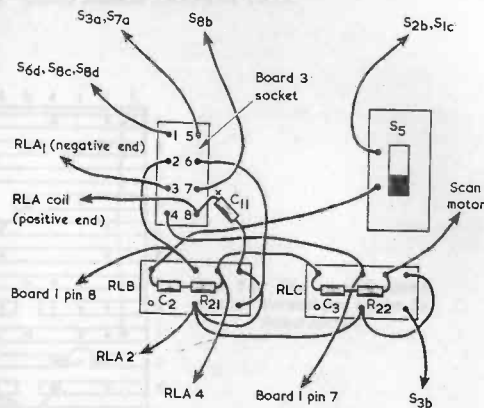
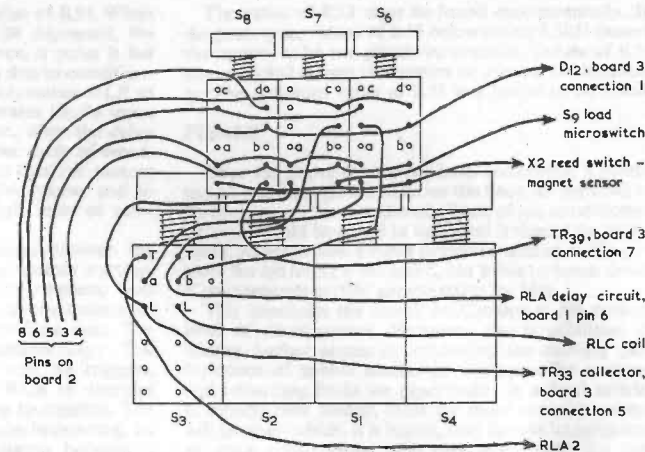

Fig. 10. Connections around Board 3 and relays RLB and RLC. Some of the wiring to the relays is already in existence

RADIO & ELECTRONICS CONSTRUCTOR

Fig. 11. New and existing wiring around switches S3 and S6 to S8



The link from D28 to H15 is removed, and in its place is fitted a link from F31 to pin 7 on the plug. A 56KΩ resistor, R49, is wired between pin 7 and pin 4, the Sn input. Thus pin 7 on the plug serves as a link because the resistor wires are not long enough to stretch the whole distance by themselves. The final step in this part of the circuitry consists of replacing the link between D30 and pin 6 by a link consisting of two diodes between B26 and pin 6, wired with the polarity shown

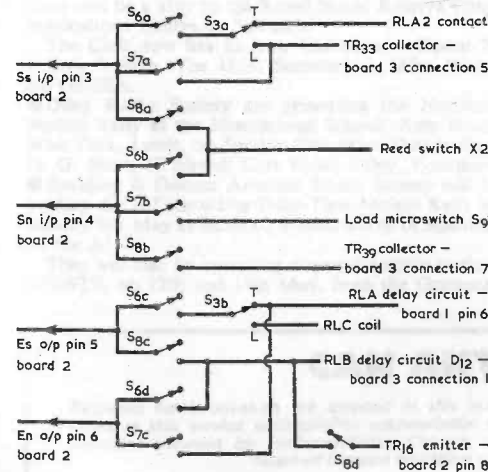

- S3 - Touch/light selector
- S4 - Forget switch
- S5 - Paralyse switch
- S6 - Select Sg
- S7 - Select weight training conditioning
- S8 - Select anxiety neurosis conditioning

Fig. 12. Illustrating in detail the selector switch functions

Table II  
Board 3 Connections

Connection Number	Nearest Hole	Board 3 Connection	External Circuit
1	A4	D12	From S6(d) S8(c), S8(d)
2	A5	R61	From RLB coil
3	A1	Negative line	From RLA1
4	R2	C13, R51	From RLC coil
5	R4	TR33 collector	From S3(a) S7(a)
6	I4	TR37, D13, R60	RLB coil
7	R5	TR39 collector	S8(b)
8	R6	Positive line	Positive line from RLA



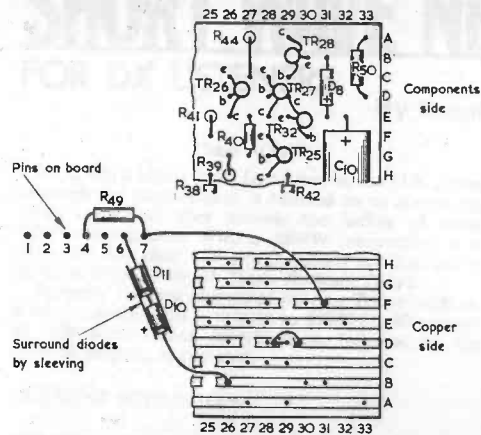

Fig. 13. Modifications to the En output circuit on Board 2. These are described in detail in the text

in Fig. 13.

Fig. 14 shows what Board 2 around the Ss input circuitry should look like after modifications. At location M5 is made a break, and the break originally at J3 is bridged by a wire link. The link between pin 2 and L5 is moved to M3, and now R47 is soldered from L5 to pin 3. The wire from pin 3 to J10 now goes to D5. Finally, a link goes from K4 to pin 8. It should be pointed out here that the pair of wires originally passing from pins 7 and 8 of the socket to switch S3(c) should be totally removed, because pin 7 is now used as part of the circuitry.

Referring to the top of the board, R23 should be removed from its present position, and another resistor, of value 2.2kΩ instead of 1kΩ, should be soldered in the new position between A4 and D4. R24 and R26 should

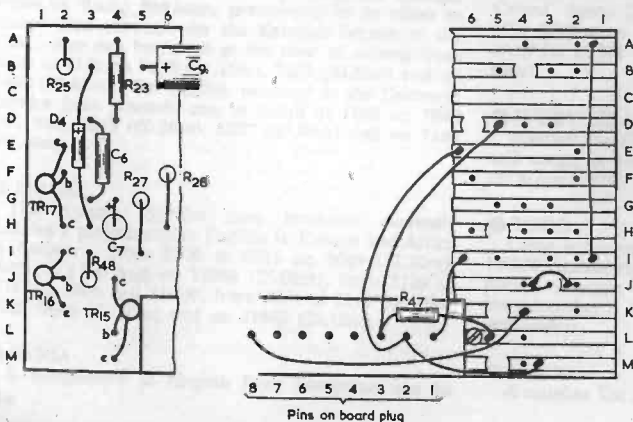

Fig. 14. The modifications that are carried out at the Ss input circuit

be removed completely. The transistor at location J2, J2 and K2 should be allowed to remain, but is now TR16 instead of TR15. A new resistor, R48, is soldered between I3 and J3, and the transistor at I4, J4 and K4 should be displaced to J4, L4 and M4 respectively.

## TESTING

The first items to test are the circuits which do not contribute anything new to Cyclops when considered by themselves, namely the circuitry around TR33 which replaces the use of RLC1 contacts, and the circuitry around TR34 to TR37, in conjunction with the modified En output circuitry.

Monitoring the output of the Ss monostable, i.e. the voltage at TR18 collector, check that shining a light into Cyclops' eye triggers the Ss monostable when both S3 and S6 are depressed. If the monostable does not trigger, then the values of R51 and R52 can be changed slightly to allow the pulse at their junction to have a greater magnitude when RLC coil energises. The monostable should not trigger when RLA is operated - if it does, then the values of R51 or C11 must be increased. With the selector switches in the same position, the magnet should be applied to the reed switch for a moment. RLB should operate for approximately three seconds. If the time is greater than about five seconds, or less than about two seconds, the value of C14 must be changed to allow for this.

The next stage is testing the circuitry around TR38 and TR39. The collector of the latter transistor should, when S8 is depressed, rise from about 0.05V to 5.25V when either of the coils of RLB operates. The Sn monostable should thus fire when RLB de-energises; that is, when the input goes positive. It is important to check that Sn monostable does not fire when RLA operates, disconnecting the bottom ends of RLB's coils from the positive line. If Sn monostable should fire under these circumstances, then C11 should be increased in value, and if Sn monostable still fires, then R60 and R61 must be increased.

With S8 still depressed, operation of RLB when the magnet is applied will check the operation of the circuitry around TR15 and TR16.

The final thing to do is check the value of R53. When Cyclops has been conditioned, with S8 depressed, the moment the coil voltage of RLB drops, a pulse is fed into Sn, which immediately evokes Es due to conditioning, thus sending a pulse to D12 which causes RLB to operate again. The moment RLB operates the Sn input is cut off, switching off Es whereupon, after the delay afforded by the RLB delay circuits, the cycle of events repeats. The desired visual effect is that Cyclops' motors should pulse momentarily, pause, pulse, pause, and so on, until conditioning ceases through lack of reinforcement.

However, a finite time interval lapses between the voltage dropping on RLB coil and the motors starting, due to the finite time it takes for the magnetic field inside RLB to collapse, and due also to the finite time required for the motors to accelerate from rest. The electronics, however, work instantaneously. The moment the voltage drops on RLB coil, Sn triggers, causing Es to trigger, and causing RLB to energise before the motors have had a chance to operate. The function of R53 is to prevent the above happening, by allowing a finite time interval to elapse between a voltage appearing on D12, and C14 charging up sufficiently to operate the Schmitt trigger.

The value of R53 must be found experimentally. In the prototype, values of R53 below about 3.3kΩ caused the motors to be completely inoperative. Values of R53 above 100kΩ caused the motors to operate continuously. The optimum value of R53 was found to be 10kΩ.

## FINALE

Once the above testing has been completed, Cyclops can be put through his paces on the floor, as opposed to performing on the workbench. Each of the conditioned reflexes should be tested in turn, and it should be found that Cyclops is now a more dedicated animal, willing to work for his living if rewarded, but liable to break down if the pressures of 'life' get too much for him.

This concludes the details on Cyclops at his present level of development. However, the possibilities of adding further senses or improving the existing performance of robots similar to Cyclops offer exciting and rewarding fields for experiment. In a final article, to appear next month, ideas for more complex robots will be given which, it is hoped, may fire the imagination of some constructors, who may even build the first all-purpose domestic robot!

## CLUB EVENTS

● University of East Anglia Radio and Electronics Club are to hear a talk, illustrated by films and slides, by Keith Schleicher, VK4KS on Friday 4th May on an expedition to the Mellish Reef. Thursday 24th May there will be a visit to the Royal Naval Reserve Communications Centre at Norwich.

The Club now has its own Clubroom - Room 29 U.E.A. Village. The Hon. Secretary is Mike Wade, c/o G3UEA.

● Otley Radio Society are presenting the Northern Mobile Rally at the Moorgrange School, Ring Road, West Park, Leeds, on Sunday 20th May. Details from D. G. Mott, 17 Newall Carr Road, Otley, Yorkshire.

● Spalding & District Amateur Radio Society will be holding the 1973 Spalding Tulip-Time Mobile Rally on Sunday 6th May at Surfleet, 4 miles north of Spalding on the A16.

They will also be operating a special activity station, GB3STF, on 12th and 13th May, from the Grammar

School, Priory Road, Spalding, in connection with the 1973 Tulip festival. The Wireless Preservation Society will have an exhibition of vintage radio on show to the public.

Details of the above from R. Harrison, G3VPR, 38 Park Avenue, Spalding, Lincs.

● Derby Radio Society have the following programme for May - 2nd. Surplus sale - 9th. Surprise Night - 16th. D. F. Practice Night, No. 2 - 23rd. Expedition to Andora A.R.C.O.N. - 30th. Film show.

Hon. Secretary F. C. Ward, 119 Green Lane, Derby.

● The British Amateur Electronics Club inform us that they have no lady members and they hope that as a result of this announcement, some of our lady readers will write to enquire about membership.

Those interested should write to C. Bogod, 26 Forrest Road, Penarth, Glamorgan, for details which he will gladly supply, together with a sample copy of the club's excellent Newsletter.

## CAN ANYONE HELP?

Requests for information are inserted in this feature free of charge, subject to space being available. Users of this service undertake to acknowledge all letters, etc., received and to reimburse all reasonable expenses incurred by correspondents. Circuits, manuals, service sheets, etc., lent by readers must be returned in good condition within a reasonable period of time.

Radio Constructor, August 1969 issue - Chas. Tyrrell, 3 Grenville Ave., Torquay, Devon, TQ2 6DS. To purchase or borrow.

Philips Oscilloscope Model GM5659 - S. Simpson, 8 Hallfield Avenue, Mickletfield, Nr. Leeds, Yorkshire - Circuit, Service Manual, loan or purchase.

Murphy Lowband Mobile Unit - R. McCormack, 44 Mountainview Park, Belfast 14 - Any information and circuit diagram, loan or purchase.

Radio Constructor, December 1962, January, February

and March 1963 - M. A. Seed, 39 Torquay Road, Newton Abbot, Devon - To purchase or borrow.

Mullard Valve Tester, Type E7600 - F. Murphy, 105 Upton Court, Upton, Wirral, Cheshire, L49 6LS - Manual or any information.

Eddystone 5640 Communications Receiver - M. Lewis, 10 Kenmore Drive, Fililton Park, Bristol, BS7 0TT - Service Sheets, Circuit or Manual.

Valve Type X78 - R. A. Read, 7A The Close, Salisbury, Wilts - To purchase.

# SHORT WAVE NEWS

FOR DX LISTENERS



By Frank A. Baldwin

Times = GMT

Frequencies = kHz

Receiving a signal from Japan here in the U.K., even although the transmission is beamed to us across the Asian continent, does provide the feeling of some achievement gained. With a 100kW transmitter, it is not often that clear and strong signals get through to us from NHK (Nippon Hoso Kyokai) Tokyo.

Probably the best chance of hearing Tokyo with an English transmission is to tune to 17855 (16.80 metres) at 0800 when station identification, followed by the news in English, is radiated.

## CURRENT SCHEDULES

### ● BANGLADESH

Radio Bangladesh, Dacca, has an External Service which radiates programmes in English as follows - from 0230 to 0300 on 9690 (30.96m) and on 15520 (19.33m); from 1230 to 1300 on 11620 (25.82m), 15520, and on 17935 (16.73m). The third transmission in English is from 1700 to 1800 on 11650 (25.75m) and on 15520.

### ● LIBYA

The External Service from Tripoli, in Arabic for the Gaza Strip and Occupied Areas (programme entitled "The Steadfast") may be logged from 1830 to 1850 on 8630 (34.76m) and on 11795 (25.43m). Also on the same two channels, directed to Morocco (programme entitled "Liberation") from 2115 to 2145.

### ● GREECE

Athens has an External Service, entirely in the Greek language except for the period 1600 to 1750 (when in Russian and various Balkan languages). The European service is from 1900 to 1950 on 7215 (41.58m).

### ● PAKISTAN

With the many (almost weekly) frequency changes made by Radio Pakistan, presumably in an effort to locate clear channels for the External Service to the U.K., they can be heard at the time of writing from 2000 to 2130 on 7290 (41.15m), 7337 (40.88m) and on 9468 (31.68m). The English newscast in the Domestic Service from Karachi can be heard at 1600 on 3940 (76.15m), 4975 (60.30m), 6257 (47.94m) and on 7240 (41.44m).

### ● ISRAEL

The External Service from Jerusalem currently radiates a programme in English to Europe and Africa as follows - from 0500 to 0515 on 9009 (33.30m), 9625 (31.17m) and on 11960 (25.08m); from 1130 to 1200 on 9009 and 11960; from 2035 to 2115 on 9009, 9625, 9645 (31.10m) and on 11945 (25.12m).

### ● SYRIA

A programme in English from Damascus can be

heard from 2030 to 2200 on 15165 (19.78m). A broadcast for expatriates "Our Sons in the World", in Arabic, may be heard from 2000 to 2030 on 15290 (19.62m).

### ● LEBANON

An English broadcast in the Overseas Service of Radio Lebanon may be heard from 1830 to 1900 on 11955 (25.09m).

## AROUND THE DIAL

### ● TURKEY

Radio Ankara, "The Voice of Turkey", can be heard with the English programme at 2200 on 11880 (25.25m). At 2215, we heard a very interesting account of Turkish cultural life.

### ● UGANDA

Kampala can be heard on the regular 4976 (60.28m) channel, usually with African music and songs just prior to 2100. At 2100 the news in English is radiated with station identification, National Anthem and sign-off at 2106.

### ● LIBERIA

Monrovia, in the form of Radio St. ELWA may be logged on 4770 (62.89m) from around 2230 onwards with songs and announcements in English.

### ● CAMEROON

Radio Garoua can often be heard on the regular 5010 (59.88m) channel from 2100 onwards, usually with African music and chants.

### ● DOMINICAN REPUBLIC

The above frequency is also that of HIMI Radio Cristal, Santo Domingo, which can often be heard after 2200 when R. Garoua is off the air. Our last log entry for HIMI was at 0206, it can't be missed at this time!

### ● IVORY COAST

Abidjan, usually with a programme of African music and songs, is worth listening for on 11920 (25.16m), try around 2030.

### ● TOGO

Lome is the easiest African station to 'catch'. The 100kW transmitter will be found on 5047 (59.44m) almost anytime during the evenings up to 2300, programming is largely in French with some African vernaculars.

### ● GHANA

A tougher Dx assignment would be Ejura on 3350

RADIO & ELECTRONICS CONSTRUCTOR

(89.55m). The programming is mainly in African vernacular and our log entry for this one is at 2150 (coping with the CW QRM will be a problem!).

### ● ANGOLA

Still dealing with Africa, how about Angola? The reception of this country here in the U.K. is not all that easy, largely owing to the low powers involved (usually 10kW or less and with omnidirectional aeriels) and the constant battle with utility QRM. However, on occasions one can make a log entry with some sense of achievement.

CR6AG Radio Commercial de Angola, Sa da Bandeira, with music, announcements and advert 'jingles' at 2008 on 4795 (62.56m).

CR6RY Radio Clube do Cuanza Sul, Novo Redondo, with Latin American type music and announcements in Portuguese at 2153 on 4840 (61.98m). Not often heard here in the U.K., the 2kW signal cannot overcome the teletype transmission usually on this channel - happily missing on this occasion until 2158 when it returned with a vengeance! Also, one must contend with Bukuvu, Zaire, on 4839 (62.00m).

CR6RZ Emisora Official, Luanda, with endless talk, or so it seemed, in Portuguese from 2100 to 2120 on 3375 (88.88m).

### ● SOUTH AFRICA

Should your problems keep you awake, why not tune to Springbok Radio with the Afrikaans All-Night Service on 3250 (92.30m)? We logged it at 0235 recently when a programme of organ music was being radiated.

At a more reasonable hour, you could tune to 21535 (13.93m) at 1300 for the programme directed to the U.K. from Johannesburg.

### ● PAKISTAN

A little further along the dial from the last mentioned frequency is that of 21590 (13.89m) where, at 1300 one can hear R. Pakistan with station identification and a programme in English usually about Pakistan affairs.

### ● EQUATORIAL GUINEA

EAJ205 Santa Isabel, Fernando Poo, can be heard on the regular 6250 (48.00m) channel from around 2000 through to 2300 here in the U.K. An English programme is scheduled from 1900 to 2100, although we recently logged it in Spanish at 2121 with good signal strength.

### ● NORTH VIETNAM

For some time now Hanoi has been back on the 60 metre band. Listed on 4895 it is, in fact, on a measured 4892 (61.31m) and has been logged many times around 2100 with military music and programme in Vietnamese.

### ● CHINA

Radio Peking may be logged on the 60 metre band, listen on 4815 (62.31m) at 2355 for the sign-off after a programme in Spanish.

Radio Peking can also be heard, with an English programme, on 6270 (47.84m) from 2100, when we listened to a commentary on life in China after station identification at 2100. R. Peking is also on 6320 (47.44m) in French at 2100.

MAY 1973

The Home Service 2 can be heard at 2100 on 6345 (47.28m), logged here at 2122 when radiating a programme of Chinese songs and music.

### ● IRAQ

Baghdad can be logged on the regular 9745 (30.78m) channel, we heard a programme about the current oil policy, in English, at 1945.

### ● CUBA

Radio Havana can be heard with the English programme to the U.K. and Europe at 2030 on 15140 (19.82m).

## TIME-CHECK

Listed here are the stations mentioned in **AROUND THE DIAL** for the convenience of those readers who wish to plan their listening periods.

GMT	Freq.	Stn.	Rcvd.
1300	21535	Johannesburg	
1300	21590	Karachi	
1945	9745	Baghdad	
2008	4795	R.C. de Angola	
2030	11920	Abidjan	
2030	15140	Havana	
2100	4892.5	Hanoi	
2100	3375	Luanda	
2100	4976	Kampala	
2100	5010	Garoua	
2100	6270	Peking	
2100	6320	Peking	
2100	6345	Peking	
2150	3350	Ejura	
2153	4840	Novo Redondo	
2121	6250	Santa Isabel	
2200	11880	Ankara	
2230	4770	Monrovia	
2355	4815	Peking	
0206	5010	Garoua	

## HERE AND THERE

In which we present a few items of interest to the Dixer.

### ● COLOMBIA

HJIG Ondas del Meta, Villavicencio, listed on 4885 but heard here on a measured 4886 (61.45m) at 2300 with LA songs and identification.

### ● ECUADOR

HCMB5 Radoi Popular Independiente, Cuenca, on a measured 4807 (62.41m) at 0010 with sports commentary in Spanish. On an earlier occasion heard at 0247 but on a measured 4808.

HCMQ1 Radio Atahualpa, Quito, at 0100 with LA music, adverts and identification on 4780 (62.76m).

### ● INDIA

AIR Madras at 0059 with programme of Indian music and identification in Hindi on 4920 (60.98m).

### ● SOUTH AFRICA

SABC with a programme of piano music, identification and newscast in English at 2100 on 3965 (75.67m).

# New Products

## WIRE STRIPPER WITH SELF-ADJUSTING BLADES



Anyone who has to strip wires will be grateful for a wire stripper that has just come onto the market. It has self-adjusting blades so that no matter what the wire gauge, the AB Mk 1F automatically adjusts and strips the wire in one easy action.

It can strip stranded or solid, aluminium or copper, round or flat, single or multiple wires. It can strip an outer sheath first and then, without adjustment, the inner wires. There is even an adjustment dial especially for extremely thin or extra thick insulations.

The AB Mk 1F weighs only 8½ ounces and is the only one of its kind available. Price £9.25 from Pact International Electronics Ltd, P.O. Box 19, Royston, Herts SG8 5HH.

## SPEED WRAP TOOL

Following their distribution agreement with the O.K. Machine and Tool Corporation, Vero Electronics can now offer from stock the G100/R3278 tool which is used to provide solderless wire wrap connections by merely squeezing the trigger. The tool is designed to accept the same Coiltite Bits and Sleeves used with electric, battery and air operated wire wrapping tools.

Wrapped wire provides a positive, uniform, gas-tight, electrical connection faster and more economically than any other method; it eliminates the need for soldering and yet no special skills are required. Coiltite Bits and Sleeves are available for 22, 24, 26, 28, 30 and 32 gauge wires.

Further details from: Vero Electronics Ltd., Industrial Estate, Chandlers Ford, Hampshire SO5 3ZR.

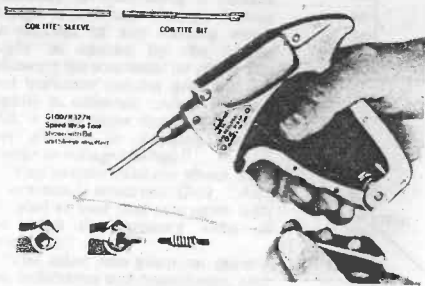

## DRA-260 REED SWITCH

The DRA-260 is an economically priced power switch suitable for switching up to 240 VA A.C. or 60 W. D.C.

This high rating is achieved by unique design and the novel use of contact materials and gas filling.

The DRA-260 is of standard size and is available in a sensitivity range of 80-120 A.T.

Typical applications include proximity switches, float switches, pulsing for counting applications, contactor and solenoid switching.

The DRA-260 is available from FR Electronics (Switching Components Group), Wimborne, Dorset, and from their distributors.

646

## BASE MOUNTING FUSEHOLDERS

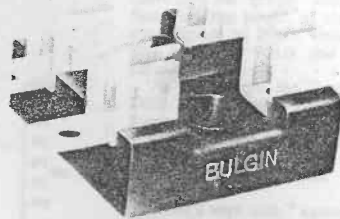

A range of five base mounting open Fuseholders, accepting either 1" x ¼" or ½" x ¼" fuses, and consisting of a twin fuse model and two single fuse models rated 13A at 250V., and two single fuse models rated 5A at 250V.

Illustrated is a two-pole open Fuseholder rated 13A at 250V and accepting 1" x ¼" fuses. The base is moulded in black thermosetting material and holds the fuse clips and connection tags. The latter accepting either solder or 250 series push-on-tabs. Fixing is by two recessed holes 0.156" 4.0mm ø at 0.590" 15.1mm crs.

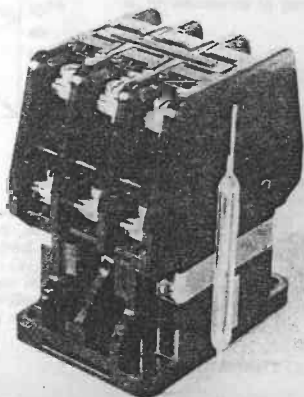

# In your workshop

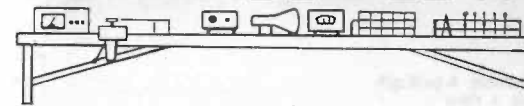

This month Smyth the Serviceman chooses a very basic subject, that of resistance, on which to expound to his assistant Dick. In the process, he manages to reveal some unusual facets of this apparently very simple electrical quantity

on and carried it over to the "Repaired" racks.

"What," called out Smyth from his bench, "was the snag?"

"Resistor gone open-circuit," replied Dick shortly. "It was in the collector load circuit of the video output transistor. Funnily enough, every set I've done this morning has had a resistor snag. I've fixed four receivers and they all had faulty resistors. The resistors had either gone high or open-circuit."

## RESISTANCE

"That," remarked Smyth philosophically, "is how things tend to go in the servicing business. All of a sudden you get a run of sets all with the same sort of fault."

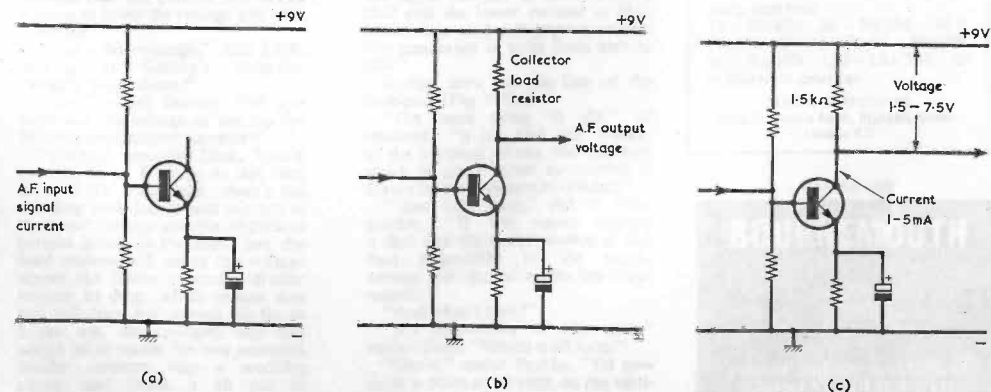

Fig. 1 (a) The input and bias circuits of a transistor in the common emitter mode  
 (b) A resistor inserted in the collector circuit causes changes in collector current to appear as changes in collector voltage  
 (c) If the collector resistor has a value of 1.5kΩ, changes in collector current of 1 to 5mA produce voltages across the resistor of 1.5 to 7.5 volts



ing the resistor to his sketch. (Fig. 1 (b).) "Let's put a few figures in this circuit. We can, for instance, say that the current gain of the transistor and the input signal amplitude are such that input signal peaks of one polarity cause the collector current to rise to 5mA and that input signal peaks of the other polarity cause the collector current to fall to 1mA. We've got 9 volts supply to play with and so we could quite reasonably try the effect of using a collector load resistor of 1.5k $\Omega$ . This would then drop a voltage of 7.5 volts at 5mA and a voltage of 1.5 volts at 1mA."

Smithy jotted the figures down on his sketch. (Fig. 1 (c).)

"I see what you're getting at now," said Dick excitedly. "The presence of the resistor allows the collector voltage to swing from 1.5 volts below 9 volts to 7.5 volts below 9 volts on signal peaks."

"That's the idea," said Smithy. "The resistor has caused a current change of 1 to 5mA to be translated to a voltage change of 1.5 to 7.5 volts."

"Blimey," remarked Dick, impressed. "I hadn't considered resistance in that light at all. Up to now I've looked upon resistance as just being something which has nuisance value!"

"Resistance does have a nuisance value," admitted Smithy. "This is because it's present in every conductor and can cause power losses. I should add, by the way, that the collector resistance example I've just mentioned is rather a rough-and-ready illustration of the function of resistance in translating a current change to a voltage change. It took no account of any loading which might be caused by the circuit following the transistor or of the fact that transistor current gain will fall slightly as collector voltage reduces. Still, it does show that resistance is very effective in changing current change to voltage change."

"You've convinced me about that, at any rate," remarked Dick. "And I'm glad to hear that you agree with me about the nuisance value of resistance!"

"The other two electrical quantities, inductance and capacitance, also have nuisance value," stated Smithy, "although these are usually only apparent at the higher frequencies. You can't design a v.h.f. circuit, for instance, without taking into account the stray inductances and capacitances that are bound to be present. Getting back to resistance, it's the nuisance value of resistance which causes us to have electricity pylons all over the country."

"Why's that?"  
"Well," said Smithy, "if you want to transmit a high level of electric power over lines you have to take into account the inevitable resistance in those lines. The voltage drop in the lines is proportional to the

current which flows in them and so the most economical method of transmitting power over long distances consists of feeding it to the lines at a high voltage and a low current, rather than at a low voltage and a high current. The only snag with the high voltage is that the lines have to be strung between whacking great insulators fitted to pylons."

But Dick was not interested in the problems of the Central Electricity Generating Board.

"One irritating thing with resistors," he remarked, "is the calculations you have to carry out when you're finding the value given when they're connected in parallel."

Smithy grinned. "There's an interesting graphical approach to that problem," he said, "and it can be useful for people who don't like doing calculations. You get a piece of graph paper and start off by drawing two vertical scales equally graduated in terms of resistance on a common base line. Like this."

Smithy drew out the vertical lines on Dick's note-pad. (Fig. 2 (a).)

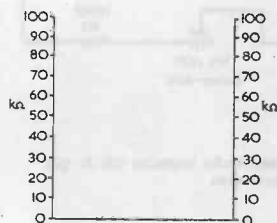

(a)

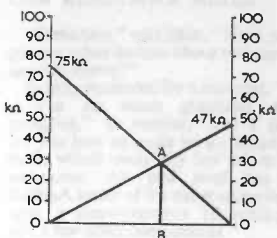

(b)

Fig. 2. How to find the value given by two resistors in parallel. First draw two graduated vertical lines, as in (a), then add further lines, as in (b). In (b), the height of line AB corresponds to 75k $\Omega$  and 47k $\Omega$  in parallel

"I've marked these lines in graduations from zero to 100k $\Omega$ ," he continued. "Let's now say we want to find the resistance given when a 75k $\Omega$  resistor is connected in parallel with a 47k $\Omega$  resistor. I draw a straight line from 75k $\Omega$  on one vertical line to the zero point on the second, and another straight line from 47k $\Omega$  on the second vertical line to the zero point on the first. These two lines cross at a point which I'll mark as A, and I then draw line AB perpendicular to the base line."

Smithy drew in the lines he had mentioned. (Fig. 2 (b).)

"I don't," said Dick, a little impatiently, "quite see where all this is leading to."

"You will in a jiffy," promised Smithy. "Because I'll now tell you that the length of the line AB corresponds to the value of the two original resistors in parallel."

"Blow me," exclaimed Dick.

"Does it?"

"It does indeed," pronounced Smithy, scribbling out a quick calculation. "My sketch isn't accurate enough to show the final value properly but, if the lines are drawn correctly on graph paper, you'll find that the length of the line AB corresponds to 29k $\Omega$ , which is what you get with 75k $\Omega$  and 47k $\Omega$  in parallel."

"It seems to me," commented Dick thoughtfully, "that this graph business could be particularly useful if you know the final resistance you want and want to find what two resistors in parallel will give you that answer."

"That's very true," agreed Smithy. "What you do in that instance is to choose what seems a likely value for one of the resistors and draw a line from that value to the zero point of the opposite vertical line. You then mark off this line at a height which corresponds to the final resistance value required and draw another line from the zero point of the first vertical line through this point, continuing on to the opposite vertical line. It cuts this vertical line at a point corresponding to the second resistance value which needs to be connected in parallel with the first."

#### POTENTIAL DIVIDER

"This is quite interesting," commented Dick. "I hadn't realised that you could solve resistance problems with graph paper."

"There's another resistance problem you can do with the aid of graph paper," said Smithy. "And this one is helpful even for those who don't mind working things out with figures. Let's say you have two resistors in series to form a potential divider and that you tap off a voltage between their junction and the lower supply rail. Like this."

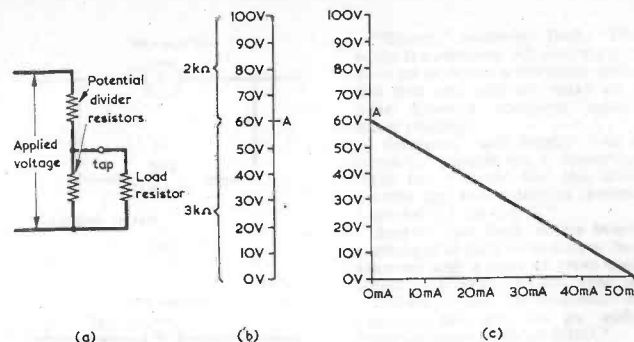

(a) (b) (c)

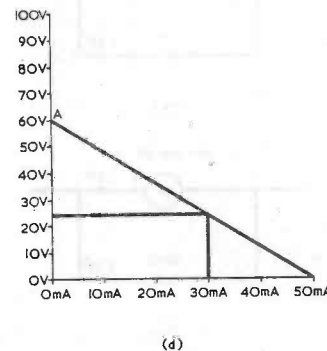

(d)

Fig.3(a) A potential divider with a load resistor between the tap and the lower end  
(b) First step in finding the relationship between tap voltage and load current  
(c) A line is drawn from tap voltage at zero current to load current at zero voltage  
(d) The line defines tap voltages for intermediate currents

Smithy drew the potential divider circuit. (Fig. 3 (a).)

"I've added a load resistor between the tap and the lower supply rail," he went on, "and it's pretty obvious that the current this draws is going to lower the voltage available at the tap."

"That's fair enough," said Dick, looking at Smithy's diagram. "What's the problem?"

"How," asked Smithy, "do you work out the voltage at the tap for different load resistor currents?"

"Blimey," protested Dick, "you'd need to be an Einstein to sort that lot out! To begin with, there's the standing potential divider current in the upper resistor and the additional current going to the load. But the load current will cause the voltage across the lower potential divider resistor to drop, which means that this will draw less current. So far as I can see, the quickest way out would be to solder the two potential divider resistors into a working circuit and check it all out in practice!"

"The mathematical calculations required aren't as bad as all that," grinned Smithy, "but it's much simpler to use the graphical method

I'm going to show you. I'll take some actual figures for this, as it makes things easier to demonstrate. Let's say that the voltage applied to the potential divider is 100 volts, that the upper resistor in the divider is 2k $\Omega$  and the lower resistor is 3k $\Omega$ . I now draw on graph paper a vertical line graduated in volts from zero to 100."

Smithy drew out the line on the note-pad. (Fig. 3 (b).)

"The next thing to do," he resumed, "is to find the voltage at the junction of the two resistors which is given when no current is drawn from the potential divider."

"That bit's easy," put in Dick quickly. "If the upper resistor is 2k $\Omega$  and the lower resistor is 3k $\Omega$  then three-fifths of the supply voltage will appear across the lower resistor."

"And what's that?"  
"It's three-fifths of 100 volts," replied Dick. "Which is 60 volts."

"Good," stated Smithy. "I'll now mark a point at 60 volts on the vertical line and call it point A. We next want to find the current which flows in the upper resistor when the lower resistor is short-circuited."

"Do we?" said Dick. "Well now,

#### Your Local Supplier

LONDON

#### THE MODERN BOOK CO.

Largest selection of English & American radio and technical books in the country.

19-21 PRAED STREET, LONDON, W2 1NP  
Tel: 01-723 4185/2926

#### ST. HELEN'S RADIO

Hi-Fi Equipment  
Tape Recorders  
Radio Receivers  
Television

SPECIALISTS IN RADIO & ELECTRONIC TEXTBOOKS

ST. HELENS GARDENS  
LONDON, W.10  
Tel: 01-969 3657

Electrolytic Capacitors by Mullard, Plessey, Erie, etc.  
UF/V

1250/25, 2000/35, 2200/25, 4700/16, 8000/30, 10,000/15, 10,000/25, 1000 + 1000/40, 16 + 16/500. All 35p each, post free. 2000/50, 2500/50, 5000/50, 10,000/50, 12,500/50, all at 50p each, post free. 16 + 16/350, 32 + 16/350, 32 + 32/350, 40 + 40/250, 50 + 50/300, 80 + 80/450, 100 + 100/385, all at 25p each, post free.

ELEKON ENTERPRISES  
224a, St. Paul's Road, Highbury Corner, London N.1

HAMPSHIRE

#### BOURNEMOUTH

LARGEST HI-FI AND RADIO COMPONENT STORE IN THE SOUTH

FORRESTERS NATIONAL RADIO SUPPLIES LTD.

70-72 Holdenhurst Road  
Bournemouth  
Telephone 25232

that will be the current which flows in 2kΩ when there's 100 volts across it. Lend me that pen, Smitty!"

Dick took the pen and proceeded to carry out the requisite calculation. "Let's see now," he muttered. "Ohm's Law says that R is equal to E over I. Which means I've got to get I over to the left, and that will make RI equal to E. But I've still got R on the left, so that must now move over to the right, which means that it goes under the E. There, that's got that bit done. I is equal to E over R!"

Triumphantly, Dick wrote out the formula and heavily underlined it. The Serviceman heaved a sigh and gazed wearily out of the window.

"Right," continued Dick briskly. "I must next substitute the figures. What's E? Ah, that's the applied voltage, which is 100."

Dick wrote the number down. "Oh yes," he went on, "and we know that R is 2kΩ, so I'll put down 2,000 for that. What's I, Smitty?"

"I," grunted Smitty, his patience slowly ebbing, "is what you're supposed to be finding out."

"Is it?" queried Dick. "Why yes, so it is. That means that I is 100 divided by 2,000. Stap me, that doesn't look right at all."

"It's perfectly all right," snorted Smitty, "if you want the answer in amps. Multiply the right hand side by 1,000 if you want the answer in milliamperes."

Dick added the figure. "Why, this is smashing," he said enthusiastically. "There are cancellations all over the place now! The answer comes to 100 divided by 2, which is 50 milliamperes."

"Hooray," responded Smitty sarcastically. "It took you some time but I have to admit you got there in the end. Yes, the current which flows when 100 volts is applied to 2kΩ is 50mA."

"I tell you," said Dick proudly, "I'm a real dab hand when it comes to working out problems."

"One day," warned Smitty, "I'll set you the problem of finding the cubic capacity of that head of yours. If, that is, I can discover any units of dimension that are sufficiently great."

"Any time, any time," responded Dick carelessly.

Smitty gave up the unequal struggle. "Well," he remarked, "we now know that 50mA will flow in the 2kΩ top resistor of our potential divider when the bottom resistor is short-circuited. Or, in other words, 50mA will flow when the load resistor is zero in value and draws maximum current. Returning to my graph, we next draw out a horizontal line from the zero end of the vertical line and mark this in units of current up to 50mA. We then draw a straight line between our previous point A at 60 volts and the 50mA point on the horizontal line, and this line tells us the voltage at the potential divider

tap for all currents from zero to 50mA."

Smitty retrieved his pen and added the lines he had mentioned. (Fig. 3 (c).)

"Gosh, that's neat," remarked Dick, looking at the diagram. "If I want to find the voltage given when the load current is, say, 30mA, I suppose all I have to do is to draw a vertical line up from this value to the sloping line and then a horizontal line over to the voltage line."

"That's the idea," agreed Smitty, drawing in the 30mA line. (Fig. 3 (d).) "And you'll find that the corresponding voltage is about 23. So the potential divider will give 23 volts at its tap when the load current is 30mA. Okay?"

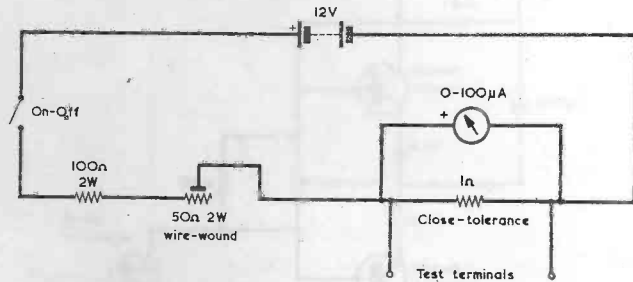

Fig. 4.—An unusual ohmmeter circuit. This is capable of measuring very low values of resistance

#### LOW RESISTANCE METER

"Definitely," said Dick. "Have you got any other dodges about resistance up your sleeve?"

Smitty pondered for a moment. "I've no more graphical approaches," he replied, "but I can tell you how to make up a resistance meter which reads very low values of resistance. All you need are a 0-100μA meter of the panel-mounting type, a close-tolerance 1Ω resistor, and a few other components."

"How does that work?" "You connect the 1Ω resistor across the meter," replied Smitty, "and pass a current through the resistor which causes the meter to read full-scale deflection. Here's the circuit."

Smitty tore the top sheet from Dick's note-pad and drew out the circuit on the clean page underneath. (Fig. 4.)

"It looks simple enough," commented Dick, as he watched the Serviceman.

"It is," said Smitty. "In fact it's the sort of thing you can throw together just to take a few measurements and then disassemble again. Now, all the standard 0-100μA meters of the panel-mounting sort have internal resistances of the order of 1,000Ω. What the actual resistance is doesn't matter, but it's bound to be very much greater than 1Ω. In consequence, if we connect a 1Ω resistor across a 0-100μA meter we can say that, as a result, we have a current-reading meter which has an internal resistance of 1Ω."

"You'll need," Dick pointed out, "a lot more than 100μA of current to get full-scale deflection now."

"You will," agreed Smitty. "If the basic meter resistance is 1,000Ω,

then 0.1 volt will appear across it when it gives full-scale deflection. That means we have to get 0.1 volt across the 1Ω resistor for f.s.d. in the meter, and this corresponds to a current of 100mA. The actual meter resistance won't be exactly 1,000Ω but it will, with most meters, be fairly close to this figure, and so we can say that, for f.s.d., we now need a current of round about 100mA. We provide this current from a 12 volt battery through the 100Ω resistor and the 50Ω pre-set potentiometer, the potentiometer being set up so that the meter gives full-scale deflection."

"Why do you use a battery voltage as high as 12 volts?" asked Dick. "Wouldn't a lower battery voltage do?"

"I've used a 12 volt battery," explained Smitty, "because this enables the series resistance, given here by the 100Ω resistor and the 50Ω pot, to be much higher in value than 1Ω. Once the pot is set up it can be assumed that a constant current

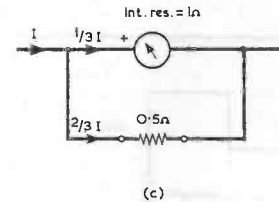
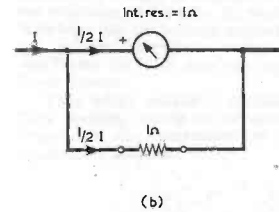
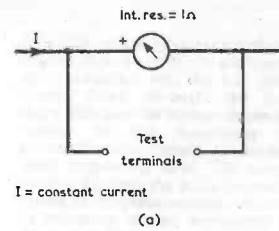

Fig. 5. (a) Effective circuit for the ohmmeter of Fig. 4

(b) For a test resistance of 0.5Ω half the constant current flows in the meter

(c) With an 0.5Ω resistor, one-third of the constant current flows in the meter

flows in a meter having an internal resistance of 1Ω, this current corresponding to full-scale deflection. Like this."

Smitty sketched out the effective circuit. (Fig. 5 (a).)

"How," queried Dick, "do you use this resistance meter?"

"You connect the test terminals to the resistance to be measured," said Smitty in reply. "If that resistance is 1Ω then half the constant current flows through the test resistance and half through the meter, which then indicates 50. If you connect an 0.5Ω resistance to the test terminals then two-thirds of the constant current goes through the test resistance and one third through the meter, and its needle indicates 33.3." (Figs. 5(b) and (c).)

"Blimey," exclaimed Dick. "This really is something. All you've got to do is to work out a few more values like that and you can make up a scale showing resistance against meter reading."

"Precisely," said Smitty. "As it happens, I made up a conversion scale for a meter like this some months ago as a matter of interest. Let's see if I can find it."

Smitty went back to his bench, rummaged around in its drawer then returned with a piece of white card, which he showed to Dick. (Fig. 6.) "There you are," he remarked. "As you can see, you can get useful readings down to about 0.02Ω."

Well, that is neat," stated Dick. "Just a few odds and ends plus one critical component, and you've got a sensitive low resistance ohmmeter! Are there any things to watch out for in practice?"

"There are one or two," said Smitty. "First of all you must wire the circuit so that the constant current from the battery goes directly through the 1Ω resistor, with the meter connected across it as though it was a voltmeter. The two test terminals must also connect direct to the ends of the 1Ω resistor. This ensures that neither the constant current nor the test resistor current flows in either of the wires which connect to the meter. And the 1Ω resistor must be a reliable component of correct value or the meter may get burnt out. If the meter resistance is a lot different from the 1,000Ω figure I assumed you might have to change the value of the 100Ω resistor accordingly in order to bring f.s.d. within the range of the 50Ω pot. The current drawn from the 12 volt battery is rather high but this shouldn't matter in most instances as the ohmmeter will only be in use occasionally. A pretty high current also flows in the resistance being measured, this rising towards the constant current level as the resist-

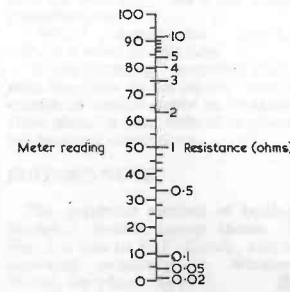

Fig. 6. Conversion scale, showing meter readings and corresponding resistance values

## Your Local Supplier

SURREY

### WITWORTH TRANSFORMERS

TV Line out-put transformers

Manufacturers of the largest range in the country. All makes supplied.

Free catalogue.

Modern BAIRD, BUSH, GEC, PHILIPS Replacement types ex-stock. For "By-return" service, contact London 01-948 3702

Tidman Mail Order Ltd., Dept. R.C. 236 Sandycroft Road, Richmond, Surrey TW9 2EQ

Valves, Tubes, Condensers, Resistors, Rectifiers and Frame out-put Transformers, Mains Transformers also stocked. Callers welcome.

SUSSEX

## E. JEFFRIES

For your new television set tape recorder, transistor radio and hi-fi equipment

PHILIPS, ULTRA, INVICTA DANSETTE, MASTERADIO, PERDIO, MARCONI, PHILCO FIDELITY

6A Albert Parade Victoria Drive, EASTBOURNE SUSSEX.

YORKSHIRE

## PASSINGHAM'S ELECTRONICS

for Government Surplus Radio & T.V. Components Electronic Components also postal service

## PASSINGHAM'S ELECTRONICS

5 Dale Street Bradford 1 Yorkshire

EIRE

## PEATS for PARTS

ELECTRONIC COMPONENTS RADIO & TELEVISION

For the convenience of Irish enthusiasts we supply

The Radio Constructor Data Books and Panel-Signs Transfers Also a postal service

Wm. B. PEAT & Co. Ltd. 28 PARNELL STREET DUBLIN 1

ance approaches zero. You might, incidentally, have a little difficulty in obtaining a close-tolerance 1Ω resistor from the usual component suppliers, but 1Ω wirewound resistors are quite easy to pick up and these are normally 5% or better, which will be in order if you don't require a very high accuracy of resistance reading. The 1Ω resistor actually dissipates less than a tenth of a watt."

"Do you have to use a panel-mounting meter?" queried Dick. "Couldn't you use a multimeter switched to a 100μA range?"

"Unfortunately not," replied Smithy. "A multimeter has a universal shunt circuit which results in a higher voltage appearing across the test terminals at f.s.d. than occurs with a panel-mounting meter. With the latter, the terminals connect direct to the meter coil, of course."

### NON-LINEAR RESISTORS

"I certainly seem to have found out a lot about resistance today," commented Dick. "I hadn't realised that there were so many different angles to the subject."

"We've only been grazing the surface," Smithy told him. "Also, the sort of resistance we've been discussing is what is offered by linear resistors. We haven't even mentioned the wide family of non-linear resistors."

"Non-linear resistors? What on earth are they?" asked Dick in alarm. "Come to think of it, I'm not too sure what you mean by linear resistors, either!"

"Linear resistors," explained Smithy, "are the types whose values are supposed to remain constant when they are used in a circuit. Ordinary fixed resistors are linear resistors. Non-linear resistors are the types having resistance which is purposely intended to change for some condition. The most common amongst these are thermistors, the values of which change with temperatures."

"Ah, I know about them," stated Dick, obviously relieved at encountering some familiar ground. "They're used in series with the heater chains in valve TV sets."

"That's right," confirmed Smithy. "The resistance of the valve heaters, when cold, is much lower than their resistance when hot, and so a thermistor is inserted in series with them to reduce the high current surge which would otherwise flow when the set is switched on. The thermistor has a high resistance when cold and a low resistance when hot, and the cold high resistance limits the current surge when the set is turned on. The thermistor then warms up and its resistance gradually drops, allowing the valve heaters to slowly rise to their final temperature."

"You also," offered Dick, "get

thermistors in transistor radios."

"In this instance," replied Smithy, "the thermistors are used to counteract changes in ambient temperature. You'll often find them wired between the bases of the two transistors in a complementary output stage." (Fig. 7.)

"I suppose," said Dick, "that the purpose of the thermistor is to reduce the transistor bias when temperature rises."

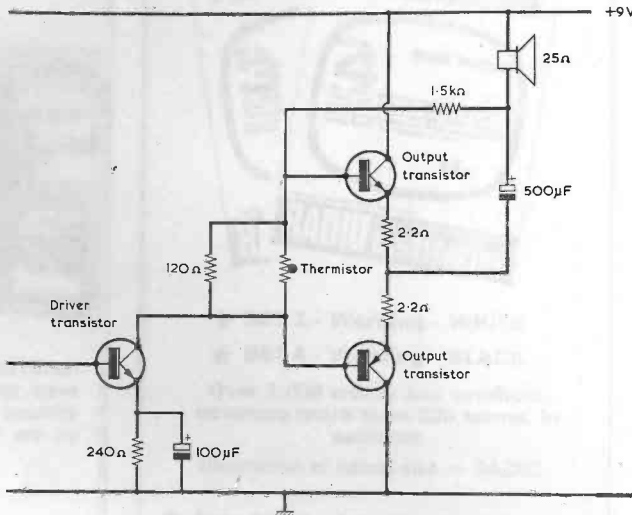

Fig. 7. A thermistor in a transistor class B output circuit. Component values are representative

"That's true," said Smithy. "When ambient temperature rises, the output transistors tend to draw more current. But the resistance of the thermistor is reduced by the temperature rise and it causes less bias current to be available, thereby counteracting the increase in transistor current. The thermistors we are talking about now, incidentally, are negative temperature coefficient types. This means that their resistance drops as temperature rises."

"Don't tell me," groaned Dick, sensing a further addition to the array of electronic devices he had to master "that there are also positive temperature coefficient thermistors."

"I'm afraid so," replied Smithy sympathetically. "You don't see them very often and, up to now, they seem to be appearing mainly in the

automatic degaussing circuits of colour TV sets. They're used here in conjunction with another type of non-linear resistor, which is known as a voltage-dependent resistor."

"Another type?" wailed Dick. "What does a voltage dependent resistor do?"

"It has a value which decreases with applied voltage," said the Serviceman. "Because of this it acts rather like a zener diode, and one of

goes into its low resistance region at around 30 to 40 volts. As soon as the set is switched on, the a.c. mains supply flows through the p.t.c. thermistor and the voltage dependent resistor to the degaussing coil around the tube, thereby producing a 50Hz degaussing field. The current passing through the p.t.c. thermistor causes its temperature to increase and its resistance to rise, whereupon the degaussing field reduces in intensity. Eventually, a stage is reached where the resistance of the p.t.c. thermistor is so high that the voltage applied to the voltage dependent resistor is insufficient for it to pass any significant current."

"That 680Ω resistor," remarked Dick, looking closely at the circuit, "maintains the thermistor in this condition, I suppose."

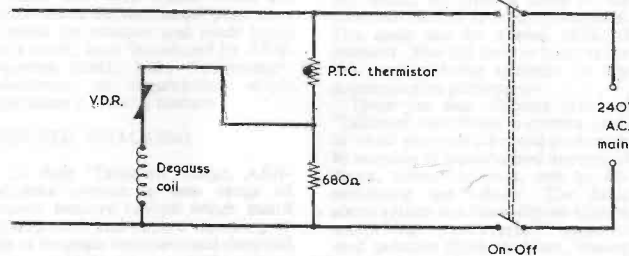

P.T.C. thermistor - VA 8650  
Voltage dependent resistor - E299DH/P230

Fig. 8. Automatic degaussing circuit, as employed in Thorn colour television receivers

"It does," confirmed Smithy. "Initially, the current passed by the p.t.c. thermistor flows mainly through the degaussing coil, but as the thermistor resistance increases, and the voltage across the voltage dependent resistor decreases, the thermistor current passes more and more through the 680Ω resistor. Eventually all the thermistor current, which is now relatively low, passes through the 680Ω resistor. So far as the degaussing effect is concerned, this starts off, immediately after switching on the set, with a strong alternating field that finally tapers off to nothing. Which is, of course, just what is required for degaussing purposes."

"Well," commented Smithy, "that's a relief at any rate." "I was thinking," remarked Dick, returning now to his bench, "that a change of subject would be pleasant. How about a nice little chat about the basics of capacitance . . ."

"Ye gods," he exclaimed. "I must be going out of my mind. I've been nattering away over here for more than an hour. Blimey, over an hour of working time wasted!"

"Not to worry," said Dick soothingly. "At least you've been able to dig into some odd corners in the resistance business which I hadn't known about before."

"But," spluttered Smithy helplessly, "there's only a minute to go before lunch-break."

"Good," said Dick resolutely, as he switched off his soldering iron and rose from his stool. "I'll put the kettle on, then."

"Don't think," pronounced Smithy to his assistant's retreating back, "that I'm going to keep on about resistance during lunch-time."

"All right, Smithy," said Dick,

over his shoulder. "We'll talk about something else."

"Well," commented Smithy, "that's a relief at any rate."

"I was thinking," remarked Dick, returning now to his bench, "that a change of subject would be pleasant. How about a nice little chat about the basics of capacitance . . ."

### EDITOR'S NOTE

The graphical method of finding potential divider output shown in Fig. 3 is due to P. F. Cundy, and it appeared originally in *Wireless World*, for May, 1944.

### TEMPUS FUGIT

Smithy closed the service manual, then looked at his watch.

MAY 1973

## LOUDSPEAKER BARGAINS

Fane pod 100 watt 18" 8/15 ohm	£21.45
Fane pod 60 watt 15" 8/15 ohm	£12.26
Fane pod 50 watt 12" 8/15 ohm	£10.17
Fane pod 25/2/25 watt 8/15 ohm	£5.94
Fane pod 15 12" 15 watt 8/12 ohm	£4.40
Fane 122/10 a or 122/12	£9.90
Fane Crescendo 15" 8 or 15 ohm	£27.50
Fane Crescendo 12" 8 or 15 ohm	£24.20
Fane 8" d/cone 808T 8 or 15 ohm	£2.64
Fane 8" d/cone roll surr. 807T, 8 or 15 ohm	£3.16
Baker Group 25 3 8 or 15 ohm	£5.00
Baker Group 35 3 8 or 15 ohm	£7.50
Baker De Luxe 12" d/cone	£9.62
Baker Major	£7.25
EM1 13 x 8 3 8 or 15 ohm	£2.58
EM1 13 x 8 type 150 d/cone 3 8 or 15 ohm	£3.85
EM1 13 x 8 type 450 1/1w 3 8 or 15 ohm	£3.25
EM1 6" 93850 4 or 8 ohm	£2.80
Elac 5 x 5 RM 109 15 ohm	£2.53
Elac 3 x 5 58 RM 114 8 ohm	£2.53
Elac 6" d/cone 6 RM 220 8 ohm	£2.59
Elac 6" d/cone roll surr. 6 RM 171 8 ohm	£2.22
Elac 4" tweeter TW6 B or 15 ohm	£1.21
Celestion PS8 for Unilox	£2.16
Celestion MF 1000 25 watt horn 8 or 15 ohm	£10.45
Elac 5" 3 ohm	£1.76
Elac 7" x 4" 3 or 8 ohm	£1.82
Elac 8" x 5" 3 8 or 15 ohm	£1.93
Wharfedale Bronze 8 RS/DD	£3.11
Wharfedale Super 8 RS/DD	£5.50
Wharfedale Super 10 RS/DD	£9.80
Goodmans 8P 8 or 15 ohm	£13.80
Goodmans 10P 8 or 15 ohm	£4.49
Goodmans 12P 8 or 15 ohm	£11.55
Goodmans 15P 8 or 15 ohm	£17.05
Goodmans 18P 8 or 15 ohm	£29.70
Goodmans Twinaesom 8	£6.79
Goodmans Twinaesom 10	£7.81
Goodmans A-vent 100 1	£5.60
Eagle DT 33 dome tweeter 8 ohm	£4.95
Eagle HT 15 tweeter 8 ohm	£3.46
Eagle CT 5 tweeter 8 ohm	£1.21
Eagle MHT 10 tweeter	£3.30
Eagle CT 10 tweeter	£1.92
Eagle X overs CW 23 28 216	£1.10
Kel T 2	£4.67
Kel T 15	£5.50
Kel B 110	£6.16
Kel B 200	£7.42
Kel B 139	£10.72
Kelkit 2	£24.75
Richard Allan 12" d/cone 3 or 15 ohm	£2.20
Richard Allan 8" 3 8 or 15 ohm	£2.27
10" x 6" 3 8 or 15 ohm	£1.92
8" x 5" 3 or 8 ohm	£1.38
7" x 4" 3 or 8 ohm	£1.38
3" 8 ohm or 80 ohm	£0.65
23" 64 ohm	£0.65
Speaker matching transformer 3/8/15 ohm	£1.10
Adastra Hiten 10" 10 watt 8 or 15 ohm	£2.80
Adastra Top 20" 25 watt 8 or 15 ohm	£6.32

## STEPHEN SPEAKER KITS AND CABINETS

send for illustrated brochure and list of recommended speakers.

### CAR STEREO SPEAKERS - ask for leaflet

PA/Disco amplifiers (car. and ins.) (£1.00)	
Baker 100 watt	£46.00
Linear 30/40	£20.00
Linear 40/50	£20.00
Linear 80/100	£50.00

FREE with speaker orders over £7  
"HiFi Loudspeaker Enclosures" book

All units guaranteed new and perfect.  
Prompt despatch.  
Carriage and insurance 25p per speaker.  
(Tweeters and Crossovers 15p each).

## WILMSLOW AUDIO

DEPT RC  
SWAN WORKS, BANK SQUARE,  
WILMSLOW, CHESHIRE. SK91HF



# RADIO & ELECTRONICS CONSTRUCTOR

## OUR NEXT ISSUE FEATURES

SILICON NETWORK  
POCKET PORTABLE

by F. G. Rayer

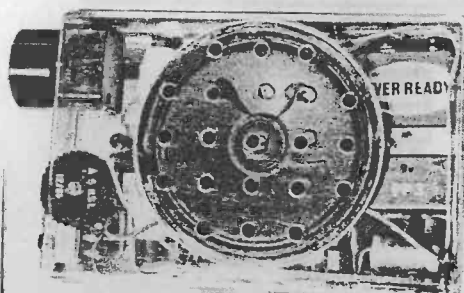

Incorporating the Ferranti integrated circuit type ZN414, this medium and long wave receiver requires a relatively small quantity of additional components. There are no alignment problems.

PLUS

MANY OTHER ARTICLES

PRICE 20p

ON SALE 1st JUNE

ORDER YOUR COPY NOW

Copies may also be obtained direct from the Publishers, 26p. including postage. Published by Data Publications Ltd, 57 Maida Vale, London W9

# RADIO & ELECTRONICS CONSTRUCTOR

## Use the NEW Strip-fix Plastic PANEL SIGNS



★ SET 3 - Wording - WHITE

★ SET 4 - Wording - BLACK

Over 1,000 words and symbols,  
covering more than 300 terms, in  
each set

Illustration of actual size = RADIO

- Easy to fix - Just cut out words required remove backing and press down
- Stapled in booklet form
- Designed to hang above workbench
- Pocket for loose cuttings
- Professional finish

### 38p per set

including V.A.T.  
(postage 3p)

The Perfect Transfer for  
the Home Constructor

Available from  
Data Publications Ltd.  
57 Maida Vale, London W9 1SN

RADIO & ELECTRONICS CONSTRUCTOR

# Radio Topics

By Recorder



WHEN A SITUATION DETERIORATES it is necessary to take more intensive steps to correct it. A particular situation whose worsening over recent years has been hardly short of dramatic is given by the theft of vehicles and their loads. What are described as unprecedented protection systems for vehicles and loads have, as a result, been introduced by AFA-Minerva (EMI) Ltd., Twickenham, Middlesex, an organisation which specialises in security matters.

### VEHICLE HIJACKING

In their 'Talisman' range, AFA-Minerva provide a new range of vehicle security devices which guard against theft and vehicle hijacking. A list of the main electronic and electrical systems that are available makes fascinating reading.

There is, to start off with, an automatic immobiliser for private cars and commercial vehicles. This device is designed to prevent a vehicle from being driven away, although it does not protect against theft of goods carried within the vehicle. With versions for both petrol and diesel vehicles, the system is primarily intended to overcome human error by ensuring that a vehicle is protected each time it is parked. The immobiliser is set up automatically one minute after switching off the vehicle's engine, and no other operation is required of the driver. The equipment is neutralised by operating a high security type of keyswitch on the dashboard.

The system is triggered off, causing the immobilisation of the engine and the sounding of the vehicle horn, whenever any of the following situations occurs: lifting the bonnet; switching on the ignition before operating the security keyswitch; removing the keyswitch wiring; stalling the engine, or operating the diesel shut-off valve, and leaving the ignition switched on; bypassing the ignition switch (petrol versions); or connecting the battery to the fuel valve (diesel versions).

MAY 1973

A higher degree of protection is provided by an automatic immobiliser system in which the keyswitch is replaced by a push-button coded switch unit. When using this solid-state device the immobiliser system is neutralised by pressing three of the unit's ten buttons in a correct sequence. The code can be altered daily, if required. You can see the buttons for this system being operated in the accompanying photograph.

There are also different types of 'Talisman' vehicle alarm systems, each of which provides all-round protection by warning of unauthorised opening of doors, bonnet or boot, and by immobilising the vehicle. The basic alarm system is a manually-set scheme comprising weatherproof magnetic reed switches fitted to doors, bonnet and boot, together with an armoured alarm sounder unit. The system is set up by turning an externally mounted security keyswitch on leaving the vehicle.

To this system can be added the setting up operation and advantages offered by the automatic immobiliser system which is set up automatically one minute after the engine is switched off. A third system incorporates the electronic coded switch unit, the system being automatically in the alarm condition at all times and even when the vehicle is in motion.

Yet another self-contained system consists of an automatic closed-circuit alarm which protects roller shutters or doors on a trailer and detects uncoupling of a trailer from its towing unit. This can be extended to protect a trailer parked without its ractor by passing a special lead through the wheels of the trailer and reconnecting it into the alarm circuit.

Finally, there is the 'Talisman' sequential anti-hijack system. This sophisticated delayed-action equipment has been designed to give an additional form of protection to the driver should his vehicle be hijacked. Unlike conventional security systems, which immobilise a vehicle immediately attempts are made to drive it away,

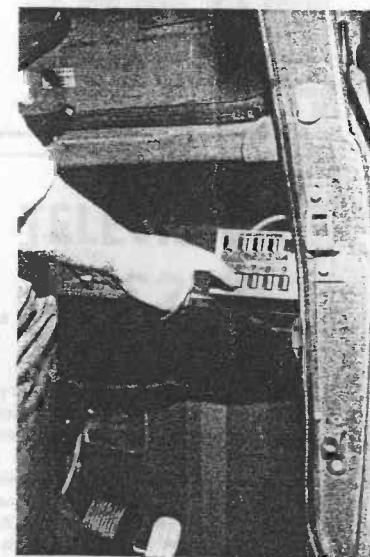

the sequential scheme allows the vehicle to operate normally for a pre-determined period. This enables the vehicle to be driven away from the scene of the hijack and reduces the risk of force being used against the driver. Once the delay interval has passed, the anti-hijack system automatically immobilises the vehicle and sounds a powerful siren which can be heard up to half a mile away.

### A LITTLE EXPERIMENT

In company, I should imagine, with quite a few readers, I was fascinated by 'In Your Workshop' in the last December issue. In this particular episode, you may recall, the indefatigable Smithy put the digital integrated

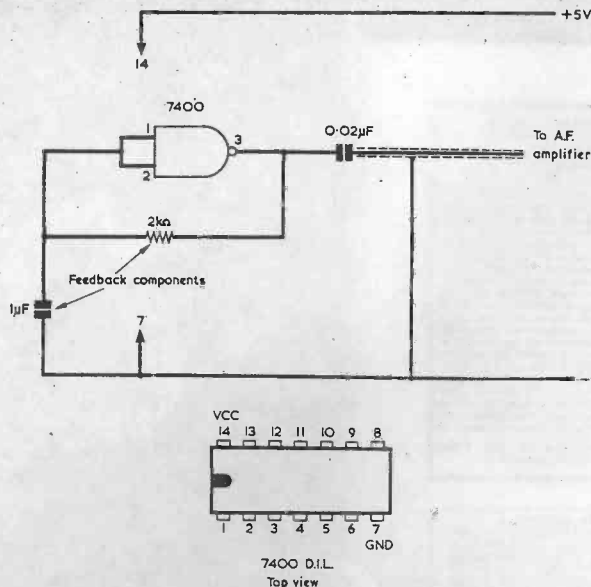

Fig. 1. An experimental oscillator employing a 7400 NAND gate. The output couples to an a.f. amplifier via the 0.02µF capacitor

circuit type 7400 through its paces and demonstrated to Dick how it could operate as a NAND gate (which is its intended function), an AND gate, an OR gate, a NOR gate and an inverter. I was so interested in these basic digital operations that I obtained a few 7400's, knocked up a 5 volt stabilized supply, and tried Smithy's circuits for myself. With, I should add, complete success.

It then occurred to me to carry out a little experiment which is probably not in the text-books. The 7400 is described as a t.t.l. quadruple 2-input NAND gate, which means that it comprises four separate 2-input NAND gates, all of these being powered (in the dual-in-line version) by 5 volts applied to pins 7 and 14, with positive to pin 14. If a NAND gate is connected as an inverter then its output is 1 when its input is 0, and its output is 0 when its input is 1. Could not this form the basis of a simple oscillator? If, say, the output were fed back to the input via an RC network then the resultant time delay would mean that a finite time would elapse before a 1 at the output reached the input to trigger off a 0 at the output and so on. I appreciate that there are i.c.'s far more suitable for functioning as an oscillator than the 7400 but I thought I would try out the idea nevertheless. It turned out to be a profitable experiment because it enabled me to learn quite a

bit more about practical t.t.l. NAND gates than I could have picked up after hours with a text-book.

The circuit I hooked up is shown in Fig. 1. I used the NAND gate which connects to pins 1, 2 and 3 of the 7400 and ignored the other three NAND gates in the integrated circuit. The NAND gate employed has both its inputs connected together, whereupon it functions as an inverter. This means that when its input is at 1 (a high positive voltage with respect to the negative supply rail) its output must be at 0 (a low positive voltage) and when its input is at 0 its output must be at 1. If, on switching on, a 1 appears at the output, the high positive voltage is applied to the 2kΩ resistor and causes the 1µF capacitor to charge. After a period the voltage across the capacitor becomes sufficiently high to correspond to a 1 at the input, whereupon the output of the gate falls to 0. The capacitor next discharges via the resistor with the result that, after a further period, the input to the gate become equivalent to a 0 and the output changes back to 1. The cycle then repeats. In practice the circuit worked quite reliably, offering a rather rough-sounding a.f. tone of around 2 to 3 kHz. The value of 2kΩ in the feedback resistor was found empirically, and was about the highest with which the circuit would function as an oscillator. Peak-to-peak output

amplitude was about 0.3 volt and current consumption, unfortunately, was at the high figure of 18mA.

I decided to slow things down a bit and so I next replaced the 1µF capacitor with a 1,000µF electrolytic, the positive terminal of this connecting to the gate input. The circuit now oscillated at about 2 cycles a second with the output swinging up to 0.5 volt on one set of half-cycles and down to 0.25 volt on the other half-cycles. Current consumption was approximately 30mA when the output was high and 10mA when the output was low.

These undesirably high currents could not possibly be caused by the external 2kΩ resistor because, even with a full 5 volts across it, this resistor could not pass more than 2.5mA.

A look at the internal circuitry of a 7400 NAND gate, which I reproduce here in Fig. 2, soon gave me the answers I needed. A well-known feature of the totem-pole output of a t.t.l. NAND gate is that, when it changes from 0 to 1 or from 1 to 0 it passes momentarily through a period when both the output transistors conduct, causing a short spike of high current to be drawn from the supply. In my oscillator circuit the output was not swinging up to a true 1 nor down to a true 0, and the output transistors were hovering, particularly at the high voltage half-cycles, near the high current spike level all the time. The heavy current was being drawn inside the i.c. through the 130Ω resistor, the two output transistors and the diode between them. The internal circuit of the 7400 gate also explained why the feedback resistor had to be as low as 2kΩ for oscillation to occur. The base resistor for the input transistor is only 4kΩ, with the consequence that a relatively high current has to flow into the input emitters to pull the input transistor base sufficiently low to register an input of 0.

So I learned, at first hand, that the totem-pole output stage of a t.t.l. NAND gate can pass a surprisingly high current if it is held mid-way between the 0 and 1 states. Also, a much higher input current is required to pull a t.t.l. NAND gate input down to 0 than is needed to raise it to 1. According to Texas Instruments literature, the maximum input current requirement for the 0 state in a 7400 gate is, under worst conditions for supply voltage variation and i.c. tolerances, no less than 1.6mA. On the other hand, input current for an input of 1 is only 40µA maximum for each input transistor emitter.

I would not recommend the circuit of Fig. 1 as being anything other than an experimental oscillator, because the continual current drawn by the i.c. is high and could possibly result in internal damage. Another point is that the 5 volt supply must have a low internal impedance. The oscillator would not run when I connected my standard testmeter (whose voltage

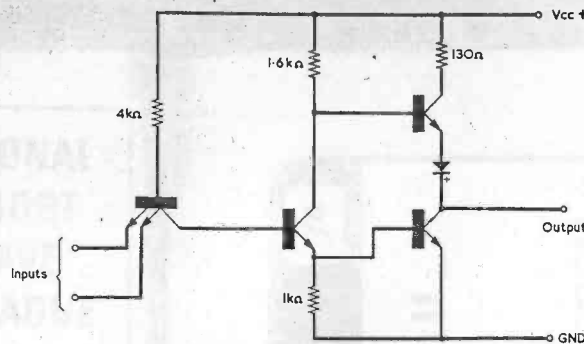

Fig. 2. The internal circuit of one of the 7400 gates

ranges are 20,000 ohms per volt) in series with the positive supply to check current consumption, since the universal current shunt in this testmeter offered too high a resistance. I had to

measure the current with a cheap 1,000 ohms per volt Japanese meter which I happened to have knocking around. When switched to read current, this meter offered much less resistance

than its considerably more expensive 20,000 ohms per volt brother!

## HOCUS POCUS

Talking of 'In Your Workshop' reminds me that, whilst digging around in some old copies of *The Radio Constructor* the other day, I found the following little gem of a puzzle at the end of one of the 'Workshop' episodes. This appeared in the issue for May 1957, so it shouldn't do any harm if, after more than 15 years, I reproduce it again here.

The numbers in an addition sum may be represented as:

HOCUS  
POCUS  
PRESTO

Each letter stands for a different number and the problem is to work out what these numbers are. For starters, it is obvious that P stands for 1 and that H must stand for 9 or 8.

I'll publish the solution next month. In the meantime, chow for now! ■



# UNDERSTANDING TELEVISION

by  
J. R. DAVIES

Over 500 pages  
300 diagrams

£2-10

POSTAGE  
20p

- Principles of 405 line reception
- Principles of 625 line reception
- Nature of the television signal
- Receiver tuner units
- A.F. and video amplifiers
- Deflector coil assemblies
- Automatic gain and contrast control
- Receiver aerials

- The cathode ray tube
- Receiver i.f. amplifiers
- Vertical and horizontal timebases
- Synchronising
- Power supply circuits
- Colour television
- COLOUR TELEVISION - 80 page section deals comprehensively with this subject

Available from  
Data Publications Ltd., 57 Maida Vale, London, W9 1SN

TO DATA PUBLICATIONS LTD 57 Maida Vale London W9 1SN

Please supply UNDERSTANDING TELEVISION, Data Book No. 17.....

I enclose cheque/crossed postal order for.....

NAME .....

ADDRESS .....

BLOCK LETTERS PLEASE

## ESSENTIAL BOOKS

HOW TO MAKE WALKIE-TALKIES FOR LICENSED OPERATION  
40p. Post & packing 10p.

The Government Surplus Wireless Equipment Handbook. Gives circuits, data, illustrations and valuable information for British/USA receivers, transmitters, trans/receivers. With modifications to sets and test equipment. Latest impression £3.25 including postage. The Scattering & Diffraction of Waves. A goldmine of information for the experimenter, radio enthusiast, student, technician. Profusely illustrated. Hardbound edition. 218 pages. Published by Oxford University Press. Price £1.60 post free. A New Guide to Hi-Fi For Beginners. By J. R. Hey Tech (CEI) MSRT. Before buying Hi-Fi equipment you must read this latest publication. It may save you pounds. An excellent guide to the purchase of ready made Hi-Fi equipment. Price only 40p. P. & P. 10p. Handbook of Transistor Equivalents and Substitutes. Includes many thousands of British, USA and Japanese Transistors. 78 pages. Only 40p P. & P. 5p. World's Short Wave, Medium & Long Wave Radio Stations & FM and TV Listing. 35p. P. & P. 5p. Cosmic Radio Waves. Start a new hobby - Radio Astronomy. This big book of 444 pages is an ideal handbook for the beginner and established enthusiast. Numerous photographs and illustrations. Published by Oxford University Press. Price £2.50. P. & P. 25p.

DEPT. RC. GERALD MYERS, Bookseller & Publisher,  
18 SHAFTESBURY STREET, LEEDS LS12 3BT

RESISTORS AT LESS THAN 1P EACH  
MINIATURE CARBON FILM RESISTORS 5% ±W E12 series. 22Ω to 2.2M Brand new. 10 for 7p, 50 for 50p. Mixed values to your choice. RESISTOR KIT 1 10 each value (as above) Total 610 £3.00 Bargain. CAPACITORS 50V Disc Ceramic (pf) 22, 33, 47, 68, 100, 150, 220, 330, 470, 680, 1000, 2p each. 20+ 1.5p each. Mixed values. CAPACITOR KIT 1 10 each value (as above) Total 110 £1.30 C.W.O. P & P 8p. NEK ELECTRONICS (R2)  
28, Carnegie Road, St. Albans, Herts.

## INTERNATIONAL



## SHORT WAVE LEAGUE

Membership £2.00 per annum (U.S.A. \$6.00) including 12 monthly issues of *Monitor* - the League journal. Including free use of all Services, QSL Bureau etc.

THE LARGEST S.W.L. ORGANISATION  
IN THE WORLD

For full details write to:

The Secretary,  
I.S.W.L.,  
1, GROVE ROAD, LYDNEY,  
GLOS. GL15 5JE.

## DATA BOOK SERIES

- DB5 TV FAULT FINDING  
124 pages. Price 50p, postage 6p.
- DB6 RADIO AMATEUR OPERATOR'S HANDBOOK  
80 pages. Price 45p, postage 6p.
- DB16 RADIO CONTROL FOR MODELS  
192 pages. Price 75p, postage 8p.
- DB17 UNDERSTANDING TELEVISION  
512 pages. Price £2.10, postage 25p.
- DB18 AUDIO AMPLIFIERS  
128 pages. Price 53p, postage 6p.
- DB19 SIMPLE SHORT WAVE RECEIVERS  
140 pages. Price 80p, postage 6p.

I enclose Postal Order/Cheque for ..... in payment for.....

NAME .....

ADDRESS .....

(BLOCK LETTERS PLEASE)

Postal Orders should be crossed and made payable to Data Publications Ltd.  
Overseas customers please pay by International Money Order.  
All publications are obtainable from your local bookseller.  
Data Publications Ltd., 57 Maids Vale, London W9 1SN

PLEASE MENTION THIS MAGAZINE WHEN WRITING TO ADVERTISERS

## CONSTRUCTOR'S DATA SHEET

## RESONANT FREQUENCIES II

The Table gives calculated resonant frequencies, in MHz, for tuned circuits having inductance and capacitance values of 5pF, 20pF, 80pF and 320pF. Times 210, 411 and 80pF are resonant at 1.25MHz.

Inductance (µH)	5pF	20pF	80pF	320pF	Inductance (µH)	5pF	20pF	80pF	320pF
25	14.2	7.10	3.55	1.77	100	7.10	3.55	1.77	0.880
30	13.0	6.50	3.25	1.62	110	6.79	3.39	1.70	0.840
40	12.1	6.05	3.02	1.51	120	6.50	3.25	1.62	0.812
50	11.5	5.72	2.81	1.40	130	6.25	3.12	1.56	0.781
60	11.0	5.46	2.63	1.32	140	6.05	3.02	1.51	0.756
70	10.6	5.25	2.52	1.25	150	5.81	2.90	1.45	0.736
80	10.1	5.05	2.40	1.20	160	5.62	2.81	1.40	0.720
90	9.62	4.81	2.30	1.15	170	5.46	2.73	1.36	0.682
100	9.20	4.60	2.21	1.10	180	5.30	2.65	1.32	0.662
110	8.81	4.41	2.13	1.06	190	5.17	2.58	1.29	0.646
120	8.51	4.25	2.05	1.03	200	5.05	2.52	1.25	0.631
130	8.22	4.11	1.99	0.994	210	4.91	2.45	1.22	0.611
140	7.95	3.97	1.93	0.965	220	4.81	2.40	1.20	0.601
150	7.72	3.86	1.87	0.937	230	4.70	2.35	1.17	0.587
160	7.50	3.75	1.83	0.914	240	4.60	2.30	1.15	0.575
170	7.31								